

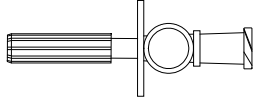
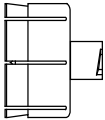
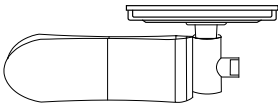
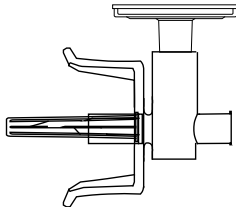
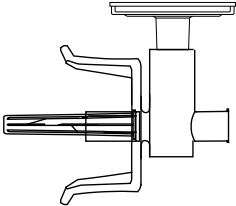
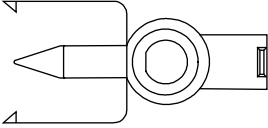

Drug Preparation and Administration Catalog

Open Vial Spikes:

Vial spikes that can be attached to various output devices to minimize contamination risks.
Can be customized as a vented or non-vented device to neutralize vial pressure.

Item	Description	Case Qty	Product Image
PH-51	Universal Vented Vial Spike	50	
PH-62	Vial Spike, 13 mm	50	
PH-70	Universal Vented Vial Spike	50	
PH-70S	Vented Vial Spike, 20 mm	50	
PH-70SL	Vented Vial Spike, 28 mm	50	
PH-72	Vented Vial Spike, 13 mm	50	

ChemoClave™ Needlefree Closed Systems and Closed System Transfer Devices (CSTDs) Cost Effective and Intuitive Luer-based Technology:

Minimize exposure to hazardous drugs and comply with recommended guidelines including USP <800>

Spinning Spiros™ Closed Male Luer:

For use on a syringe or administration sets. Available with spin feature to minimize deactivation by user; also available pre-bonded on syringes.

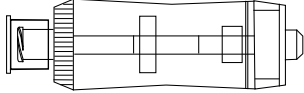
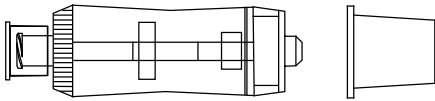
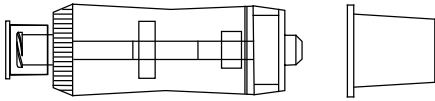
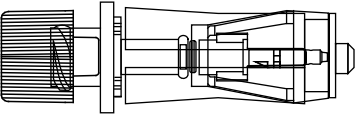
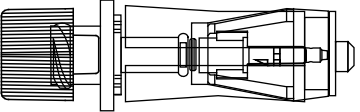
Item	Description	Case Qty	Product Image
CH2000S	Spinning Spiros Closed Male Luer	100	
CH2000S-C	Spinning Spiros Closed Male Luer, Red Cap	50	
CH2000SC-10	Spinning Spiros Closed Male Luer, Red Cap, 10 units	50	
CH2000	Spiros Closed Male Luer	100	
CH2000-10	Spiros, Closed Male Luer, 10 Units	50	

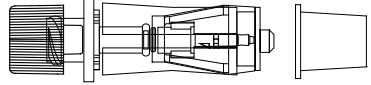
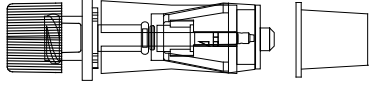
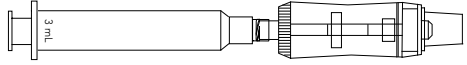
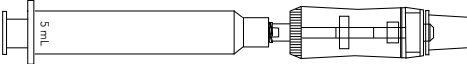
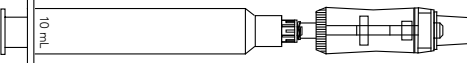
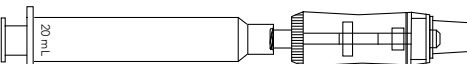
CH2000-C	Spiros Closed Male Luer, Red Cap	50	
CH2000-PC	Spiros Closed Male Luer, Purple Cap	50	
CH2003	3 mL Syringe with Spinning Spiros, Red Cap	50	
CH2005	5 mL Syringe with Spinning Spiros, Red Cap	50	
CH2010	10 mL Syringe with Spinning Spiros, Red Cap	50	
CH2020	20 mL Syringe with Spinning Spiros, Red Cap	50	

CH2030	30 mL Syringe with Spinning Spiros, Red Cap	50	
CH2060	60 mL Syringe with Spinning Spiros, Red Cap	25	

ChemoClave Vial Spikes with External Balloon Design:

The balloon allows for a closed automatic pressure equalization with reconstituted drugs. Balloon capacity of 100 mL of air. Allows access to vials with 13 mm, 20 mm, and 28 mm closure. *CH-82 balloon capacity 20 mL of air

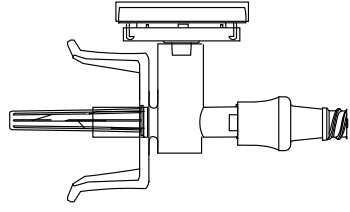
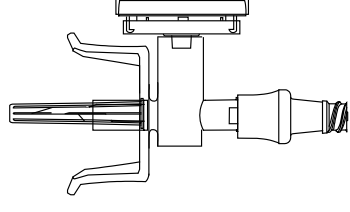
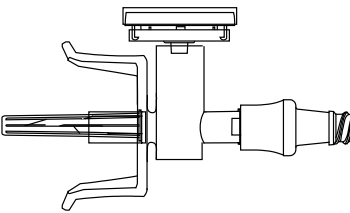
Item	Description	Case Qty	Product Image
CH-80S	ChemoClave Vial Spike, 20 mm	50	
CH-80S-4	ChemoClave Vial Spike, 20 mm, 4 units	50	 x4
CH-80SL	ChemoClave Vial Spike, 28 mm	50	

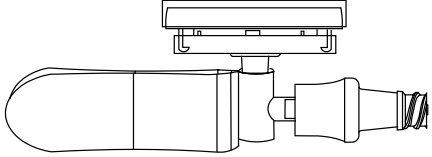
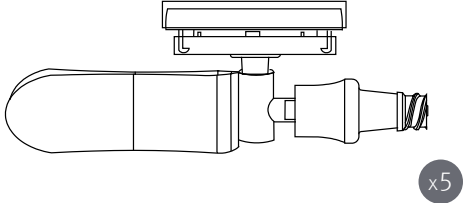
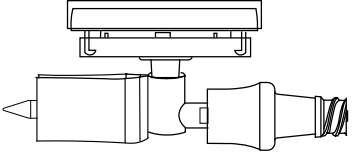
CH-80	ChemoClave Universal Vial Spike, 20 mm and 28 mm	50	
CH-80-5	ChemoClave Vial Spike Universal, 20 mm and 28 mm, 5 Units	25	
CH-82	ChemoClave Vial Spike, 13 mm	50	

ChemoClave Vial Spikes:

Allows access to vials with 13 mm closure without vent.

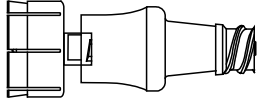
Item	Description	Case Qty	Product Image
CH-62	ChemoClave Vial Spike, 13 mm	50	

ChemoClave Vented Vial Spikes:

A 0.22 micron hydrophobic filter automatically equalizes vial pressure. Allows access to vials with 13 mm, 20 mm, and 28 mm closures.

Item	Description	Case Qty	Product Image
CH-70	ChemoClave Universal Vented Vial Spike, 20 mm and 28 mm	50	

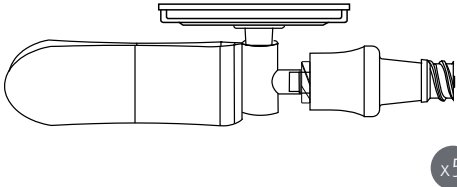
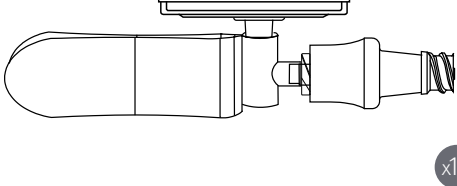
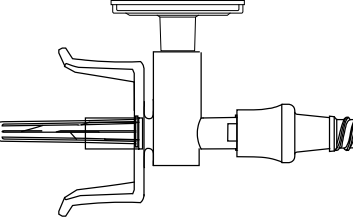
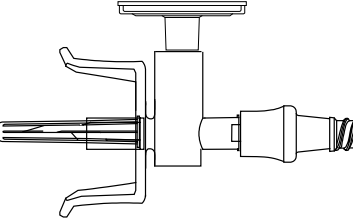
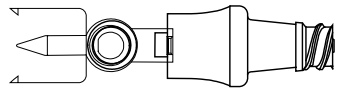
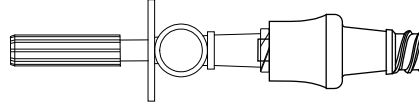
CH-70-5	ChemoClave Universal Vented Vial Spike, 20 mm and 28 mm, 5 Units	50	
CH-70-10	ChemoClave Universal Vented Vial Spike, 20 mm and 28 mm, 10 Units	25	
CH-70S	ChemoClave Vented Vial Spike, 20 mm	50	
CH-70SL	ChemoClave Vented Vial Spike, 28 mm	50	
CH-72	ChemoClave Vented Vial Spike, 13 mm	50	
CH-51	ChemoClave Vented Vial Spike, 20 mm and 28 mm	50	

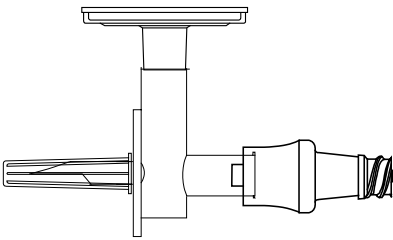
CH-53	ChemoClave Vented Vial Spike, 20 mm	50	
-------	-------------------------------------	----	---

ChemoClave Bag Spikes:

For use with primary pump set or secondary administration sets. Integrated Clave connector for closed system to the IV bag.

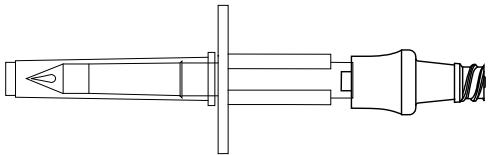
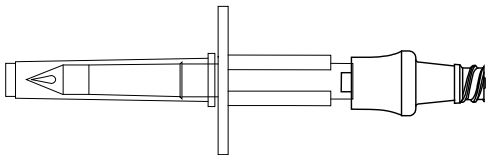
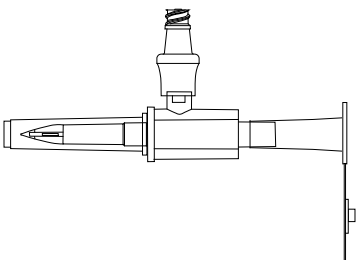
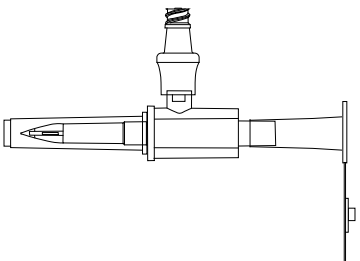
Item	Description	Case Qty	Product Image
CH-10	ChemoClave Bag Spike	50	
CH-10-10	ChemoClave Bag Spike, 10 Units	25	 x10
CH-12	ChemoClave Bag Spike with Clave Additive Port, Dry Spike Adapter	50	
CH-12-5	ChemoClave Bag Spike with Clave Additive Port, Dry Spike, 5 Units	50	 x5

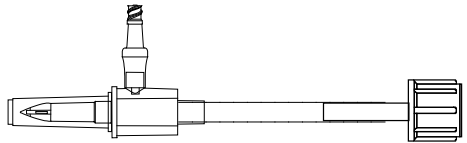
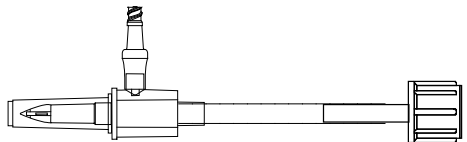
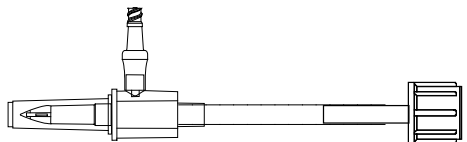
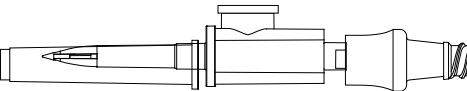
CH-13	ChemoClave Bag Spike with Clave Additive Port	50	
CH-13-5	ChemoClave Bag Spike with Clave Additive Port, 5 Units	50	 x5
CH-13-10	ChemoClave Bag Spike with Clave Additive Port, 10 units	25	 x10
CH-14	ChemoClave Vented Bag Spike	50	

ChemoClave Bag Spike Adapter:

For use with ChemoClave Bag Spike and any primary pump infusion set. Bonded Spiros to ensure closed system.

Item	Description	Case Qty	Product Image
CH3034	5" (13 cm) Bag Spike Adapter w/Spiros, Vented Cap, 3" Tubing, Priming Cap	50	

ChemoClave Secondary Administration Sets:

Secondary sets with bonded CSTD component that require no additional assembly and minimize risk of any accidental disconnection to help you comply with <USP> 800. Can be customized based on your facility needs.

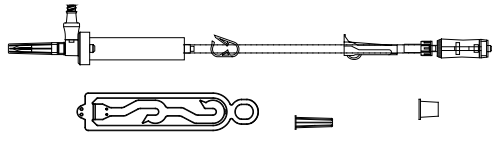
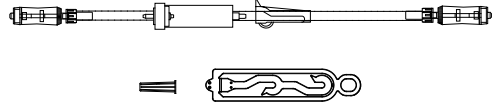
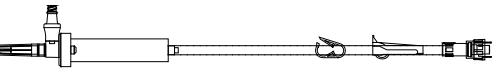
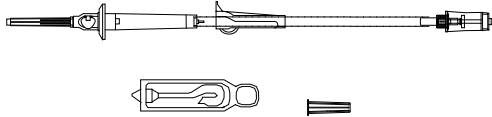
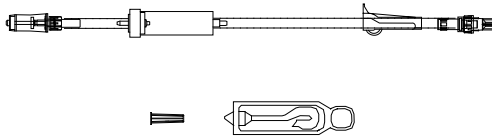
Item	Description	Case Qty	Product Image
CH3011-C	31" (79 cm) 20 Drop Admin Set with Integrated Clave Drip Chamber, Pinch Clamp, Roller Clamp, Spiros with Drop-in Red Cap, Priming Cap, Bag Hanger	50	
CH3020	40" (102 cm) 20 Drop Admin Set Spiros, In-Line Drip Chamber, Roller Clamp, Spiros, Priming Clamp, Bag Hanger	50	
CH3274	40" (102 cm) 10 Drop Admin Set with Integrated Clave Drip Chamber, Pinch Clamp, Roller Clamp, Rotating Luer (distal end open)	50	
CH3025	41" (104 cm) 15 Drop Admin Set, Vent, Roller Clamp, Spiros, Priming Cap, Bag Hanger	50	
CH3029	40" (102 cm) 20 Drop Admin Set with Spiros, In-Line Drip Chamber, Roller Clamp, Rotating Luer, Priming Cap, Bag Hanger	50	

ChemoClave Bi-Fuse Administration Set with Anti-Siphon Valve:

For use as a secondary administration set with any primary pump set.

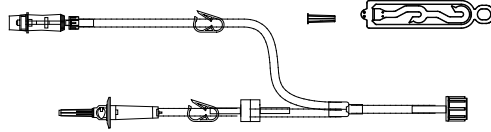
Item	Description	Case Qty	Product Image
CH3294	27" (69 cm) 15 Drop Bifuse Add-On Set with Drip Chamber, Spiros with Red Cap, In-Line Check Valve, Vented Cap, Bag Hanger, Tubing	50	

ChemoClave Extension Set:

For use with any primary infusion set with bonded CSTD component to ensure closed system.

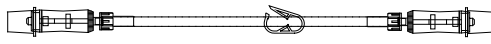
Item	Description	Case Qty	Product Image
CH3327	30" (76 cm) Ext Set with 2 Spiros with 2 Red Caps, Pinch Clamp	50	

ChemoClave Pediatric Sets:

Smallbore tubing sets with bonded CSTD component to ensure closed system.

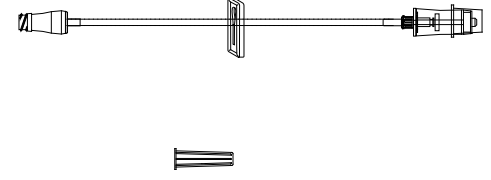
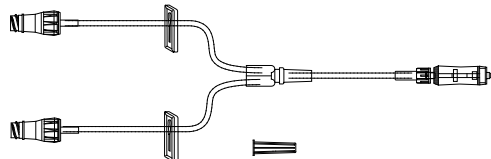
Item	Description	Case Qty	Product Image
CH3147	60" (152 cm) Smallbore Ext Set with MicroClave™, Slide Clamp, Spiros, Red Cap, Priming Cap	50	
CH3379	7" (18 cm) Smallbore Bifuse Ext Set with 2 MicroClave Clear, Spiros, 2 Slide Clamps, Priming Cap	50	

ChemoClave Kits:

A complete line of pre-packed oncology kits with all CSTD components to save time, space, and reduce package waste.

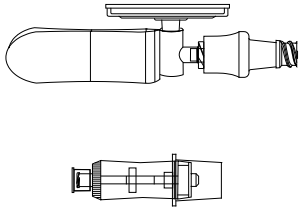
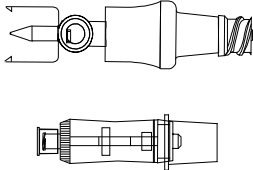
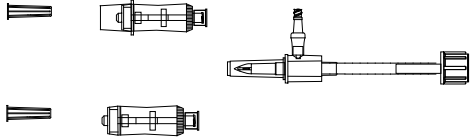
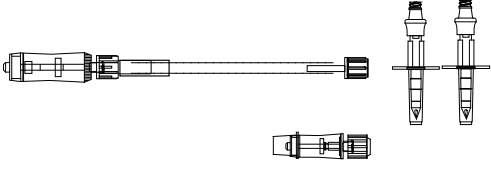
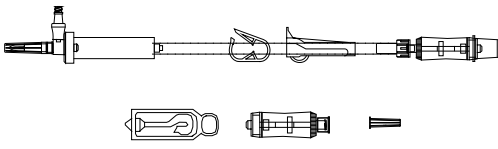
Item	Description	Case Qty	Product Image
CH3546	Oncology IV Push Kit with Clave Universal Vented Vial Spike; Spinning Spiros with Red Cap	50	
CH3547	Oncology Preparation Kit (IV Push) with 13 mm Vented Vial Spike; Spinning Spiros with Red Cap	50	
CH3260	Oncology Primary IV Kit, Bag Spike with Clave Additive Port, Spinning Spiros with Red Cap, Spinning Spiros, 2 Priming Caps	50	
CH3366	Oncology Kit, 6" (15 cm) Bag Spike Adapter with Spiros, 2 Drop-In Access Devices with Clave, Spiros with Red Cap, Tubing	50	
CH3322	Secondary IV Oncology Kit: 31" (79 cm) Secondary Admin Set with Bonded Spiros, Drip Chamber, Clave, Roller Clamp, Pinch Clamp, Priming Cap, Spinning Spiros	50	

ChemoClave Intravesical:

Allows you to safely prepare and administer mitomycin and bacillus calmette-guerin (BCG) with closed system. Customization available depending on facility needs.

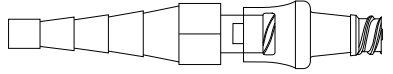
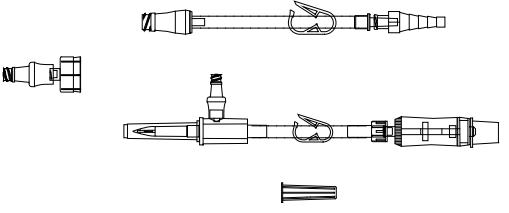
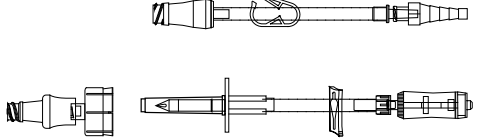
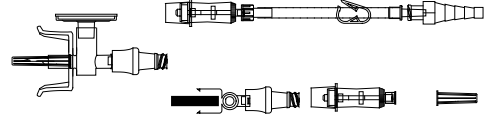
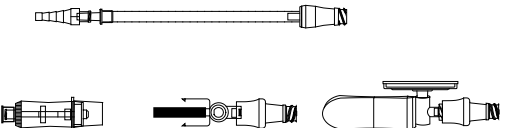
Item	Description	Case Qty	Product Image
CH3900	Graduated Adapter With Clave	50	
CH3507	Intravesical Kit with 20" (51 cm) Ext Set with MicroClave, Graduated Connector, Transfer Set with Clave Additive Port, Spiros, Red Cap; 13 mm Vial Spike with Clave, Tubing	50	
CH3927	Intravesical Kit with 20" (51 cm) Ext Set with MicroClave, Graduated Connector, Clamp, Transfer Set with Spiros, 13 mm Closed Vial Spike with Clave, Tubing	50	
CH3943	Intravesical Kit with 12" (31 cm) Ext Set, Spiros w/Red Cap, Clamp, Graduated Adapter; ChemoClave Vented Vial Spike, 20 mm; ChemoClave™ Vented Vial Spike, 13 mm; Spiros w/Red Cap; Non-DEHP Tubing	25	
CH3946	Intravesical Kit with ChemoClave Vented Vial Spike, 13 mm; ChemoClave Universal Vented Vial Spike, 20 mm and 27 mm; Spiros Closed Male Luer, Red Cap (for syringe); 16" (41 cm) Ext. Set with MicroClave; Graduated Adapter	50	

ChemoClave Accessories:

Components used with ChemoClave System that include syringe transfer components and protective caps.

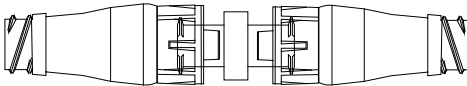
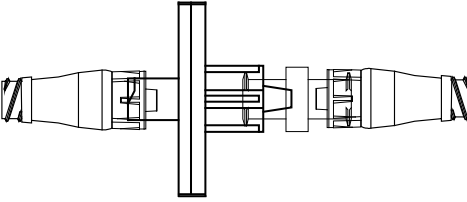
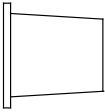
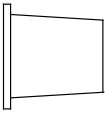
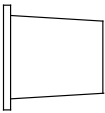
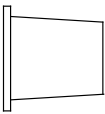
Item	Description	Case Qty	Product Image
CH-33	Double MicroClave Syringe Transfer Set	50	
CH-34	Double MicroClave Syringe Transfer Set with 0.2 Micron Filter	50	
CH-CAP	Cap, Sterile	50	 x5
CH-CAP5	Cap, Sterile, 5 Units	50	 x5
CH-CAP10	Cap, Sterile, 10 Units	50	 x10
CH-CAP-P	Cap, Purple, Sterile	50	

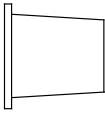
CH-CAP10-P	Cap, Purple, Sterile, 10 Units	50	 x10
------------	--------------------------------	----	--

ChemoLock Needlefree Closed System Transfer Devices (CSTDs) Membrane-to-membrane Technology with a Single-motion “Click to Lock” Design:

Minimize exposure to hazardous drugs and comply with recommended guidelines including USP <800>

ChemoLock Injector:

For use on syringe or administration sets. Available with spin feature to help prevent accidental disconnection and pre-bonded on syringes.

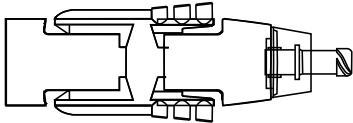
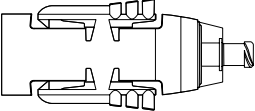
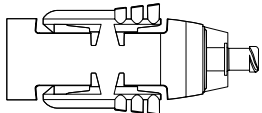
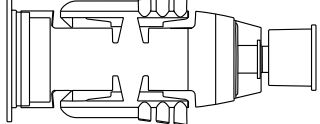
Item	Description	Case Qty	Product Image
CL2000S	ChemoLock Injector	50	
CL2000S-5	ChemoLock Injector, 5 Units	50	 x5
CL2000S-10	ChemoLock Injector, 10 Units	50	 x10
CL2000S-RC	ChemoLock Injector, Red Cap	50	

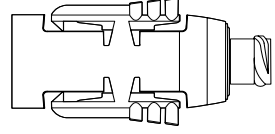
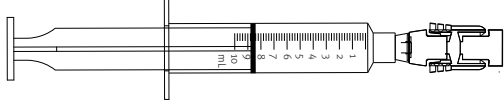
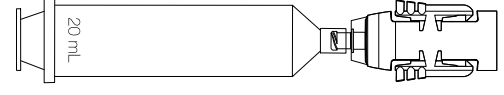
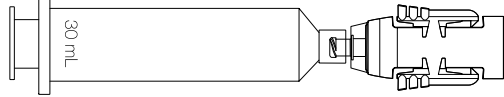
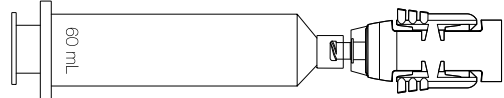
CL2000	ChemoLock Injector, Non-Spinning	50	
CL2010	10 mL Syringe w/Spinning ChemoLock Injector	50	
CL2020	20 mL Syringe w/Spinning ChemoLock Injector	50	
CL2030	30 mL Syringe w/Spinning ChemoLock Injector	50	
CL2060	60 mL Syringe w/Spinning ChemoLock Injector	25	

ChemoLock Port:
For use on patient IV line.

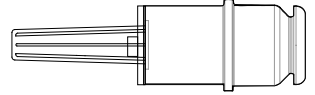
Item	Description	Case Qty	Product Image
CL2100	ChemoLock Port	50	

ChemoLock Vial Spikes with external balloon design:
The balloon allows for a closed automatic pressure equalization with reconstituted drugs. Balloon capacity of 100 mL of air. Allows access to vials with 13 mm, 20 mm, and 28 mm closure. (NOTE: The CL-82 balloon capacity is 20 mL of air)

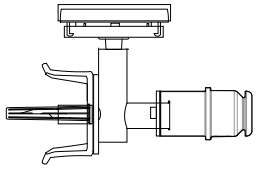
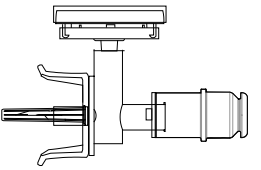
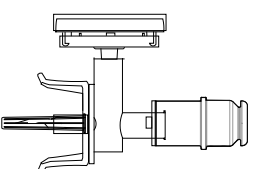
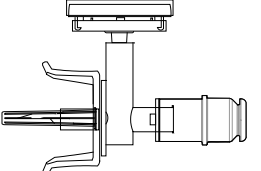
Item	Description	Case Qty	Product Image
CL-80S	ChemoLock Vial Spike, 20 mm	50	
CL-80S-5	ChemoLock Vial Spike w/Skirt, 20 mm, 5 Units	25	 x5
CL-80S-10	ChemoLock Vial Spike, 20 mm, 10 units	25	 x10
CL-80SL	ChemoLock Vial Spike, 28 mm	50	

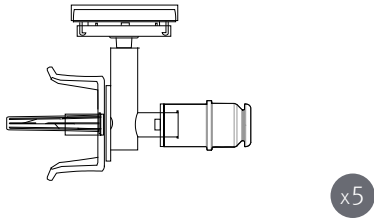
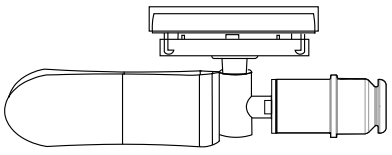
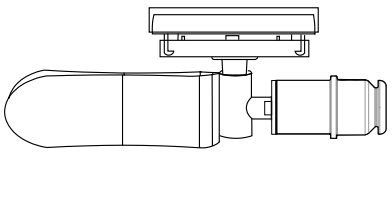
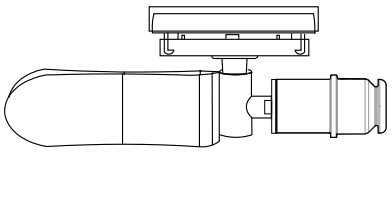
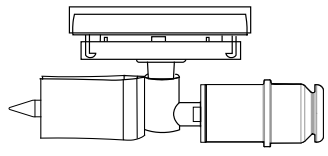
CL-80SL-5	ChemoLock Vial Spike, 28 mm, 5 units	25	
CL-80	ChemoLock Vial Spike, 20 mm and 28 mm	50	
CL-80-5	ChemoLock Vial Spike, 20 mm and 28 mm, 5 Units	25	
CL-80-9	ChemoLock Vial Spike, 20 mm and 28 mm, 9 Units	25	
CL-82	ChemoLock Vial Spike, 13 mm	50	

ChemoLock Vial Spikes:
Allows access to vials with 13 mm closure without a vent.

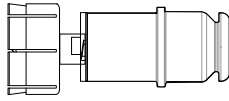
Item	Description	Case Qty	Product Image
CL-62	ChemoLock Vial Spike, 13 mm	50	

ChemoLock Vented Vial Spikes:
A 0.22 micron hydrophobic filter automatically equalizes vial pressure. Allows access to vials with 13 mm, 20 mm, and 28 mm closures.

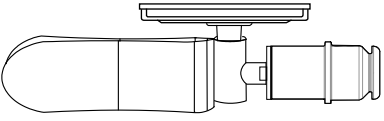
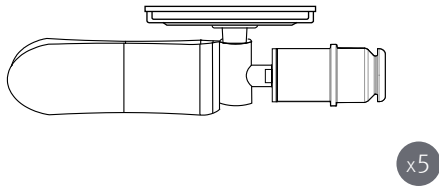
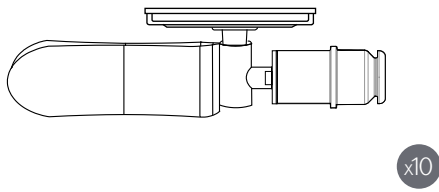
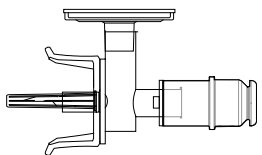
Item	Description	Case Qty	Product Image
CL-70	ChemoLock Universal Vented Vial Spike, 20 mm and 28 mm	50	
CL-70-5	ChemoLock Universal Vented Vial Spike, 20 mm and 28 mm, 5 units	50	
CL-70-10	ChemoLock Universal Vented Vial Spike, 20 mm and 28 mm, 10 units	25	
CL-70S	ChemoLock Vented Vial Spike, 20 mm	50	

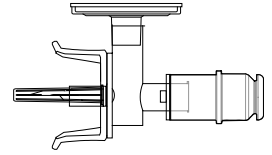
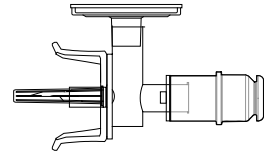
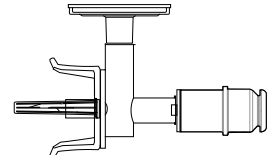
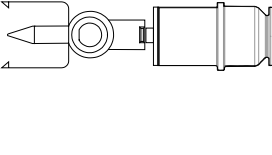
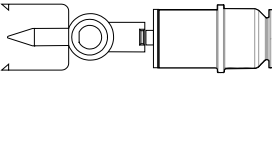
CL-70S-5	ChemoLock Vented Vial Spike, 20 mm, 5 Units	50	 x5
CL-70S-10	ChemoLock Vented Vial Spike, 20 mm, 10 Units	25	 x10
CL-70SL	ChemoLock Vented Vial Spike, 28 mm	50	 x5
CL-72	ChemoLock Vented Vial Spike, 13 mm	50	 x10
CL-72-10	ChemoLock Vented Vial Spike, 13 mm, 10 Units	25	 x10

ChemoLock Bag Spikes:

For use on any solution container for use with primary pump set or secondary administration sets. Integrated port connector for closed system to the IV bag.

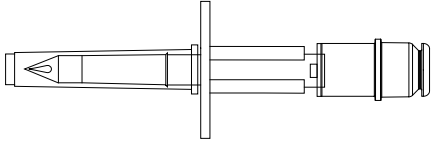
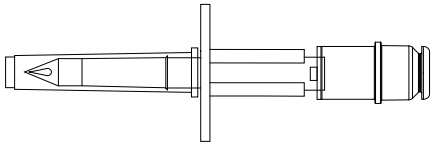
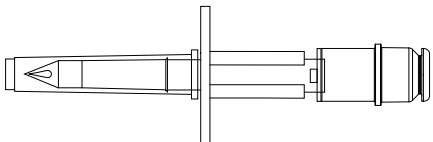
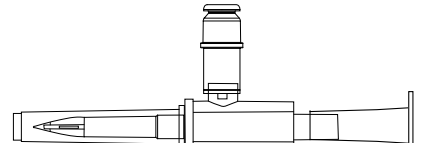
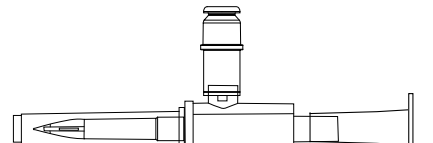
Item	Description	Case Qty	Product Image
CL-10	ChemoLock Bag Spike	50	 x5
CL-10-5	ChemoLock Bag Spike, 5 units	50	 x5
CL-10-10	ChemoLock Bag Spike, 10 units	25	 x10
CL-12	ChemoLock Bag Spike with Additive Port, Dry Spike	50	 x5
CL-12-5	ChemoLock Bag Spike with Additive Port, Dry Spike, 5 Units	50	 x5

CL-14	ChemoLock Bag Spike with Vent	50	
CLH-12	ChemoLock Bag Spike with ChemoLock Additive Port, Clave (Circle Prime), Dry Spike Adapter	50	
CL3955	ChemoLock Bag Spike with ChemoLock Additive Port and Side Port (Circle Prime)	50	

ChemoLock Bag Spike Adapter

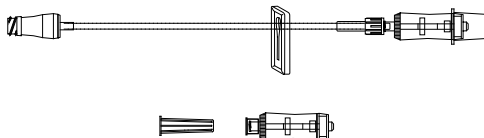
Item	Description	Case Qty	Product Image
CL3534	5" (13 cm) Bag Spike Adapter w/ChemoLock, Vented Cap, Non-DEHP Tubing	50	

ChemoLock Secondary Administration Sets:

Secondary sets with bonded CSTD component that require no additional assembly and minimize risk of any accidental disconnection to help you comply with USP <800>. Can be customized based on your facility needs.

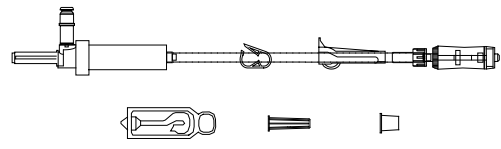
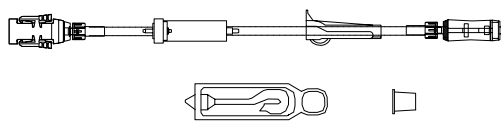
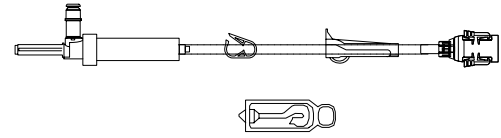
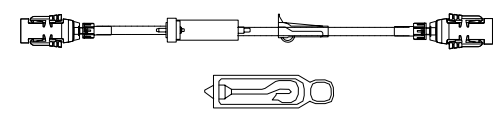
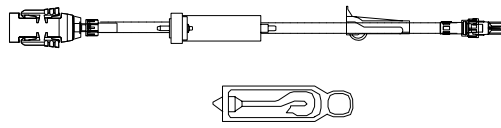
Item	Description	Case Qty	Product Image
CL3011	30" (76 cm) Admin Set w/20 Drop Integrated ChemoLock Drip Chamber, Spiros, Hanger, Drop-In Red Cap, Non-DEHP Tubing	50	
CL3020	40" (102 cm) Admin Set w/ChemoLock, 20 Drop In-Line Drip Chamber, Spiros, Bag Hanger, Drop-In Red Cap, Non-DEHP Tubing	50	
CL3511	30" (76 cm) 20 Drop Admin Set w/Integrated ChemoLock Port Drip Chamber, ChemoLock, Hanger, Non-DEHP Tubing	50	
CL3520	40" (102 cm) Appx 5.2 mL, Admin Set w/2 ChemoLock, 20 Drop In-Line Drip Chamber, Bag Hanger, Non-DEHP Tubing	50	
CL3529	42" (107 cm) Appx 5.2 mL, Admin Set w/20 Drop In-Line Chamber, ChemoLock, Bag Hanger, Non-DEHP Tubing	50	

ChemoLock Secondary Administration Sets with In-Line Filter:

Allow for secondary administration of drugs that require use of an in-line filter at the bedside.

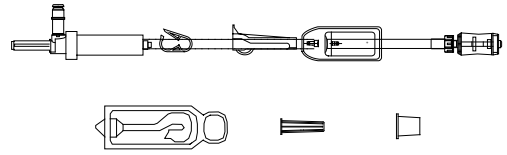
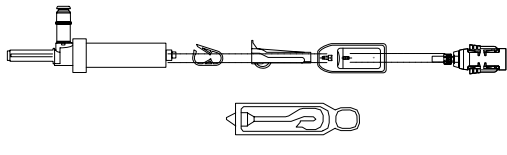
Item	Description	Case Qty	Product Image
CL3028	30" (76 cm) 20 Drop Admin Set w/Integrated ChemoLock Drip Chamber, 0.2 Micron Filter, Spiros, Hanger, Drop-In Red Cap, Non-DEHP Tubing	50	
CL3528	30" (76 cm) Appx 6.3 mL, 20 Drop Admin Set w/Integrated ChemoLock Port Drip Chamber, 0.2 Micron Filter, ChemoLock, Hanger, Non-DEHP Tubing	50	

ChemoLock Bi-Fuse Administration Set with Anti-Siphon Valve:

For use as a secondary administration with any primary pump set.

Item	Description	Case Qty	Product Image
CL3294	27" (69 cm) Bifuse 15 Drop Add-On Set w/ ChemoLock, Vented Cap, Bag Hanger, Non-DEHP Tubing	50	

ChemoLock Extension Sets:

For use with any primary infusion set with bonded CSTD component to ensure closed system.

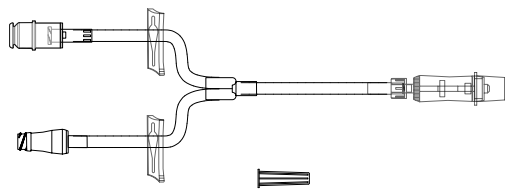
Item	Description	Case Qty	Product Image
CL3932	7.5" (19 cm) Bifuse Ext Set w/ChemoLock Port, ChemoClave, Spiros, Red Cap, 2 Clamps, Non-DEHP Tubing	50	

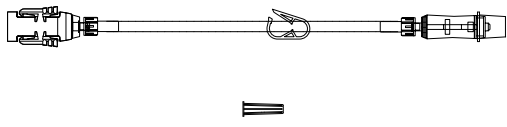
CL3935	30" (76 cm) Ext Set w/ChemoLock, Spiros w/Red Cap, Priming Cap, Clamp, Non-DEHP Tubing	50	
--------	--	----	---

ChemoLock Kits:

A complete line of pre-packed oncology kits with all CSTD components to save time, space, and reduce package waste.

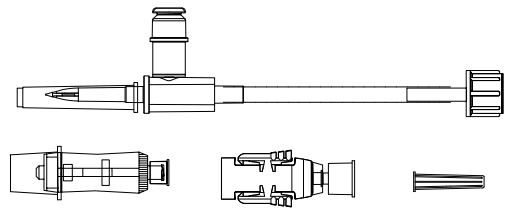
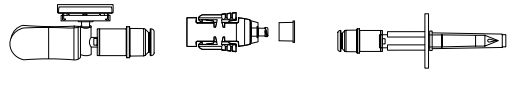
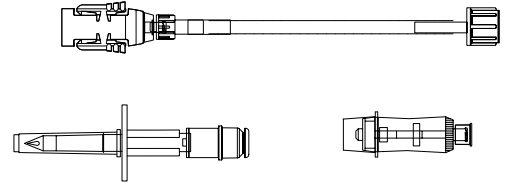
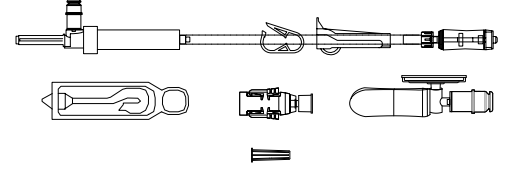
Item	Description	Case Qty	Product Image
CL3538	ChemoLock Kit w/5" (13 cm) Add-On Set w/ChemoLock Additive Port, Vented Cap, ChemoLock, Spinning Spiros w/Red Cap, Non-DEHP Tubing	50	
CL3952	ChemoLock Kit w/ChemoLock Port, Closed Vial Spike, ChemoLock, ChemoLock Port Bag Spike	50	
CL3946	ChemoLock Primary IV Preservation Setup Kit: Includes everything required to set up a single primary infusion set that can be used for multiple hazardous drug deliveries. <ul style="list-style-type: none"> > ChemoLock Bag Spike > ChemoLock 5" Add-on Set > Spiros Closed Male Luer (for administration) 	50	
CL3929	ChemoLock Kit w/31" (79 cm) 20 Drop Admin Set w/Integrated ChemoLock Port Drip Chamber, Spiros, ChemoLock, ChemoLock Universal Vented Vial Spike, Bag Hanger, Non-DEHP Tubing	50	

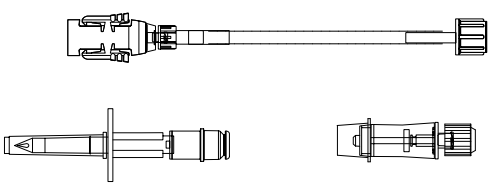
CL3941	ChemoLock Hybrid IV Push Kit: ChemoLock Injector with Clave Adaptor, Spinning Spiros w/Red Cap	50	
CL3963	ChemoLock Kit w/5" (13 cm) Add-On Set w/ ChemoLock w/Red Cap, Vented Cap; ChemoLock Port w/Bag Spike; Spiros Closed Male Luer w/Red Cap	50	

CL3968	Oncology Kit w/21" (53 cm) Ext Set w/ChemoLock Port, Graduated Adapter; Transfer Set w/ ChemoLock Additive Port, ChemoLock; ChemoLock Vial Spike, 13 mm; Non-DEHP Tubing	50	
CL3927	Oncology Kit w/ 21" (53 cm) Ext Set w/ChemoLock Port, Graduated Connector; Transfer Set w/ ChemoLock; 13 mm Closed Vial Spike w/ ChemoLock Port; Non-DEHP Tubing	50	

ChemoLock Intravesical:

Allows you to safely prepare and administer mitomycin and bacillus calmette-guerin (BCG) with closed system. Customization available depending on facility needs.

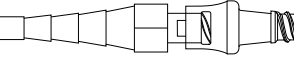
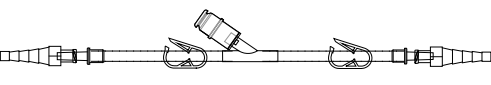
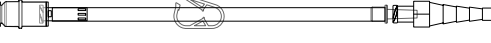
Item	Description	Case Qty	Product Image
CL3900	Graduated Connector w/ChemoLock Port	50	
CL3364	9" (23 cm) Ext Set w/ChemoLock Port, 2 Clamps, 2 Graduated Connectors, Non-DEHP Tubing	50	
CL3967	7.5" (19 cm) Ext Sets w/ChemoLock Port, Clamp, Graduated Connector, Non-DEHP Tubing	50	

ChemoLock Accessories:

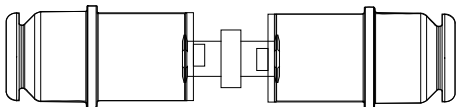
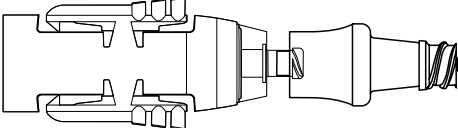

Components used with ChemoLock System that include syringe transfer component and protective caps.

Item	Description	Case Qty	Product Image
CL-33	Double ChemoLock Port Syringe Transfer Set	50	
CL-34	Syringe Transfer Set w/MicroClave, ChemoLock Port	50	
CL2000SCP	ChemoLock with Clave	50	

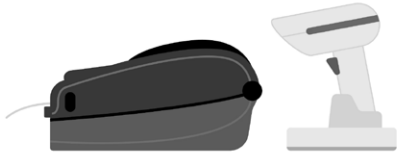
CL-CAP	Cap, Sterile, Red	100	
CL-CAP5-P	Cap, Sterile, 5 units	50	

DS2300	Accessories Pack (Barcode Scanner, Dock, Printer)	1	
--------	--	---	---

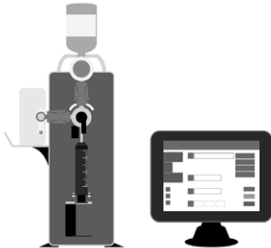
Diana Compounding Workflow System:
Automated sterile compounding for the accurate, safe, and efficient preparation of hazardous drugs.

Item	Description	Case Qty	Product Image
DS2000	Diana Syringe Pump Module (Includes Technician Tablet and Docking Station)	1	
DS2100	Technician Tablet w/ Docking Station	1	
DS2200	Remote Verification SW and Tablet w/ Docking Station	1	

Diana Workflow System Compounding Sets:
Proprietary sets to be used with our Diana Automated Compounding System.

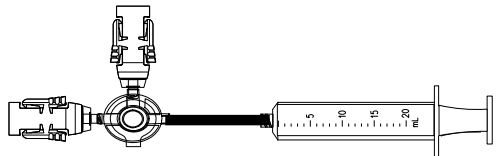
Item	Description	Case Qty	Product Image
CL6000	Diana 2.0 Syringe Set, ChemoLock	1	

Diana Automated Drug Compounding System:
Automated sterile compounding for the accurate, safe, and efficient preparation of hazardous drugs.

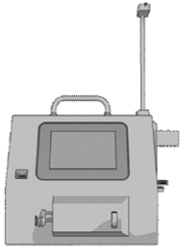
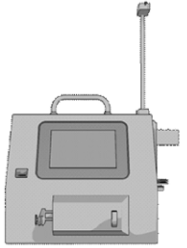
Item	Description	Case Qty	Product Image
CL5132	Diana Automated Compounding System with Barcode Scanning	1	
CL5000	Diana Automated Compounding System with Drop Down List	1	

Diana System Compounding Sets:

Proprietary sets to be used with our Diana Automated Compounding System.

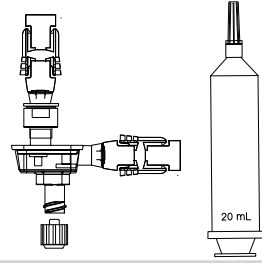
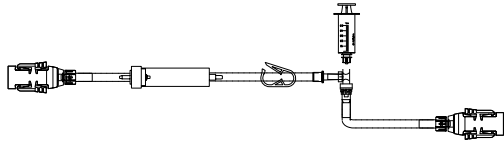
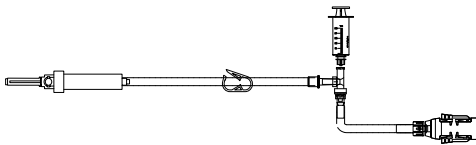
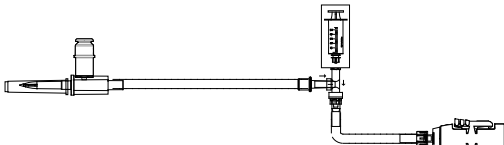
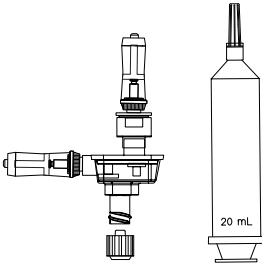
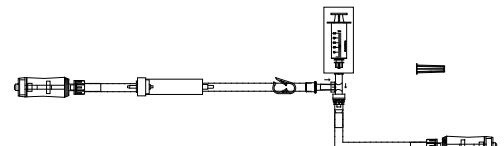
Item	Description	Case Qty	Product Image
CL4000	Channel One Cassette with 20 mL Syringe	50	
CL4001	Channel Two Diluent Set with 50 mL Syringe, Drip Chamber, and 2 ChemoLock	25	
CL4002	Channel Two Diluent Set with 50 mL Syringe, Drip Chamber, Bag Spike and 1 ChemoLock	25	
CL4009	47" (119 cm) 50 mL Diluent Set for Channel 2 w/Bag Spike w/ChemoLock Additive Port, ChemoLock	25	
CH4000	Channel One Cassette with 20 mL Syringe	50	
CH4001	Channel Two Diluent Set with 50 mL Syringe, Drip Chamber, and 2 Spiros	25	

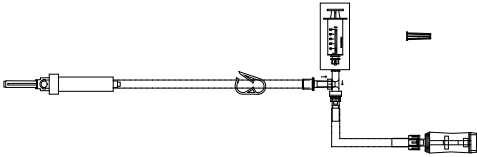
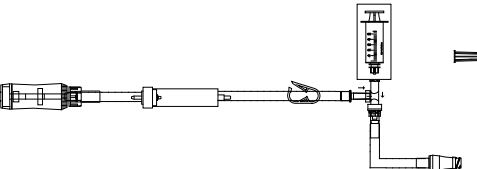
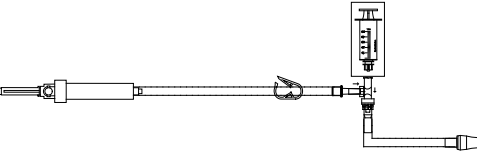
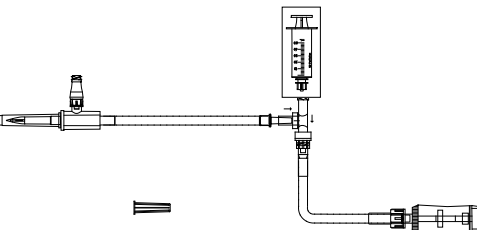
CH4002	Channel Two Diluent Set with 50 mL Syringe, Drip Chamber, Bag Spike, and 1 Spiros	25	
CH4003	Channel Two Diluent Set with 50 mL Syringe, Drip Chamber, 1 Spiros, and 1 MicroClave Clear	25	
CH4004	Channel Two Diluent Set with 50 mL Syringe, Drip Chamber, Bag Spike, and 1 MicroClave Clear	25	
CH4009	Channel Two Diluent Set with 50 mL Syringe, Bag Spike with MicroClave Additive Port, and 1 Spiros	25	

PharmAssist™ Device:

Fluid Dispensing Pump that is easy to use for fast transfers of standard non-hazardous fluids in pharmacy.

Item	Description	Case Qty	Product Image
PUMP	Pharm-Assist Pump	1	

PharmAssist Device Sets:

Proprietary sets to be used with our PharmAssist Pump.

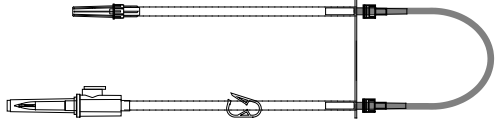
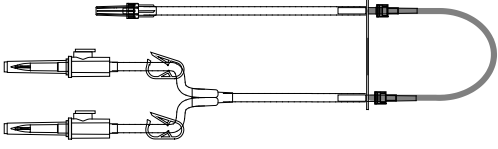
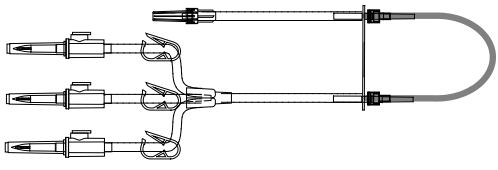
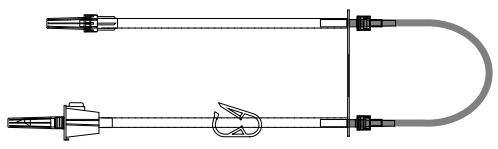
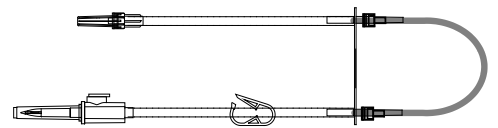
Item	Description	Case Qty	Product Image
BX01	Single Lead Heavy Duty Tubing	30	
BX02	Dual Lead Heavy Duty Tubing	25	
BX03	Triple Lead Heavy Duty Tubing	25	
LPA01	Single Lead Tubing for Use w/Lipids	30	
PA01	Single Lead Tubing	30	

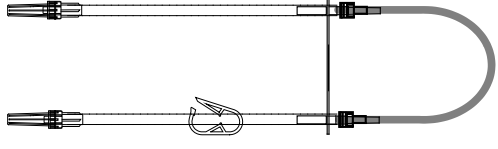
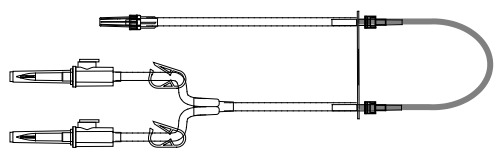
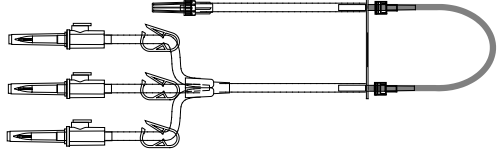
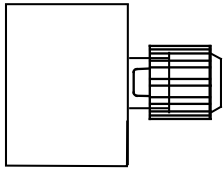
PA01LL	Single Lead Tubing w/Double Luer	30	
PA02	Double Lead Tubing	25	
PA03	Triple Lead Tubing	25	
SA250	Syringe Adaptor	250	
SH01	Syringe Holder	1	