

CLINICALLY DESIGNED PORTFOLIO



Infusion Technology

PRODUCT SPECIFICATIONS



Clinically Designed Portfolio

Striving to ensure customers and patients get best-in-class medical devices, EMED's executive team provides a unique balance of experience, vision and expertise. We believe in what we do and how we do it, consistently delivering results with integrity, teamwork, focus and respect.

EMED's innovative designs provide patients and clinicians with devices that improve safety and patient satisfaction.

EMED SCIg60™ Infuser

The SCIg60™ Infuser is a reusable, constant pressure, mechanical, non-electronic ambulatory infusion pump intended for use in the home or hospital environment.

It is approved for reimbursement by the Centers for Medicare and Medicaid Services under code E0779 (USA) along with multiple reimbursement systems worldwide, and is offered with a warranty.

EMED's innovative design has resulted in a highly robust, ergonomic and reliable pump. It is the first mechanical syringe infusion system cleared by the FDA specifically for infusion of Immunoglobulin G (IgG) into subcutaneous tissue.

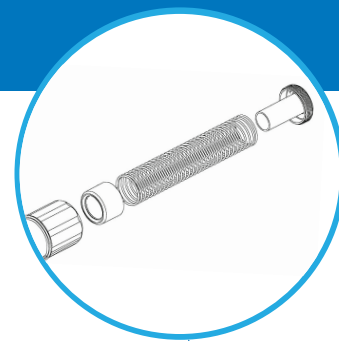

The SCIg60™ Infuser is comprised of:

- 11" precompressed spring
- 12" device
- 3 moving pieces
- 2 support legs
- 1 syringe latch
- Optimized for 60mL syringe

FEATURES

- Portable, lightweight and quiet
- Mechanically powered, non-electric, no batteries
- Maximum operating pressure of 16.8 psi
- Constructed with top grade materials
- Biocompatible to ISO 10993-1

BENEFITS

- Easy for clinicians to train patients for home use
- Virtually no maintenance
- 3 year warranty on SCIg60™ Infuser

ADVANTAGES

- Offers control of infusion therapy without the cost of an electric pump
- Is extremely robust and provides stable and consistent performance after long term use of 4,200 cycles
- Flow rate data charts are available for specific applications
- Is supported by a technical team

ORDERING INFORMATION

EMED REORDER NUMBER	ITEM DESCRIPTION	QTY PER BOX
FP-0010002	SCIg60 Infuser	1

Infuset™

Fixed Flow Rate Controller

CLINICALLY ENGINEERED FIXED FLOW RATE CONTROL

EMED's Infusets are fixed flow rate control infusion sets developed to be compatible with various mechanical infusion devices in the market. Infusets are rated to operate within pressures of 1-29 PSI and ensure usability with a wide variety of therapies.

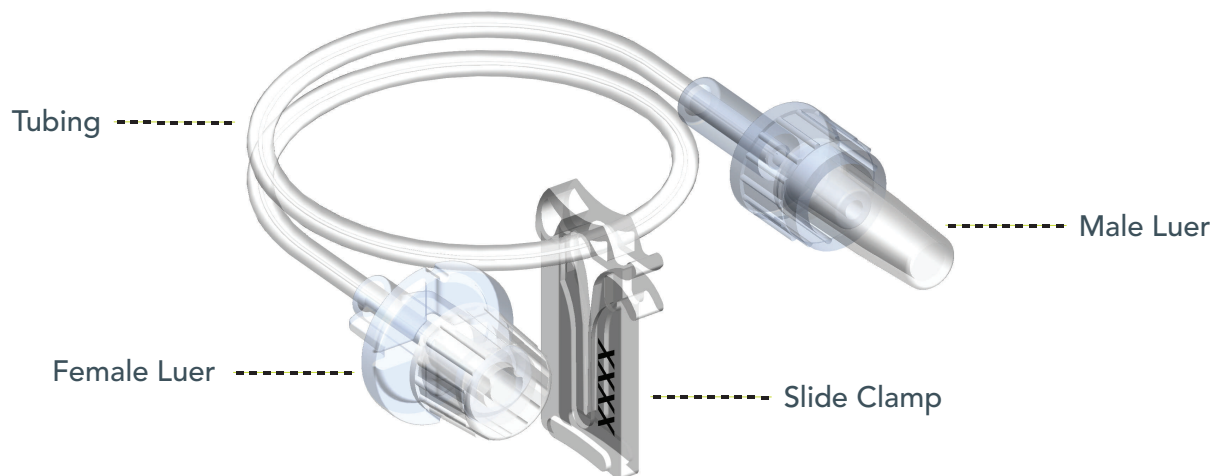

FEATURES

- Minimal priming volume
- Pressures up to 29 PSI
- Highly flexible tubing
- Universal luer fittings to fit standard syringes and needle sets
- Optimized luer design with enhanced structural support (disk)
- Translucent ergonomic clamp

BENEFITS

- Reduced waste of biologics
- Simplified ambulatory use
- Compatible with multiple biologics
- Compatible with multiple mechanical pumps

ADVANTAGES

- High precision. Accuracy levels above 90%
- Manufactured with superior polymers to minimize chemical interaction with pharmaceuticals
- Equipped with a male and female luer lock to connect to virtually any needle set and mechanical pump
- Flow rate data charts for specific applications
- Competitively priced, low single use cost

Innovation and Improvement of Clinical Protocols

Striving to ensure customers and patients get best-in-class medical devices.

Quick Reference (See instructions for use for complete guide)

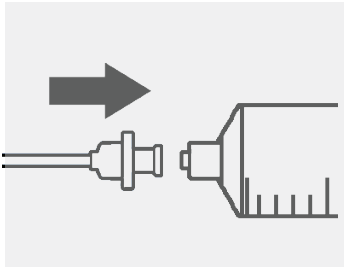

CONNECT syringe male luer lock (MLL) to Infuset female luer lock (FLL).

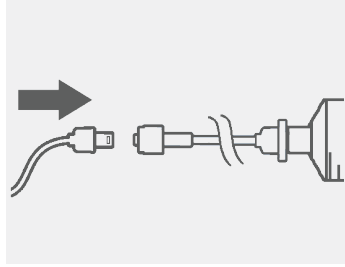

CONNECT Infuset male luer lock (MLL) to specified patient administration set female luer lock (FLL).

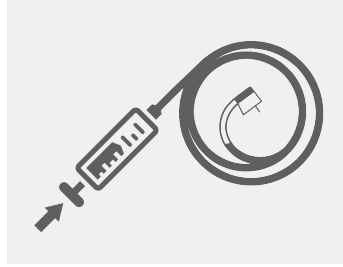

PRIME the tubing by carefully pushing on the syringe plunger to fill the tubing with immunoglobulin solution, or as instructed by your healthcare provider

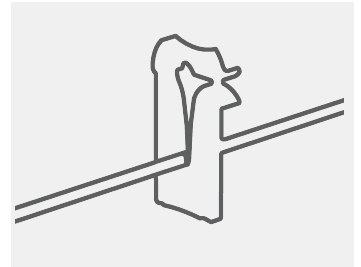

USE SIDE CLAMP provided with Infuset to prevent flow of immunoglobulin solution.

Ordering Information

EMED REORDER NUMBER	INFUSET REFERENCE	AVERAGE FLOW RATE WITH SCIg60 INFUSER (ML/HR)	AVERAGE FLOW RATE WITH FREEDOM60 (ML/HR)	QTY PER BOX	CROSS REFERENCE TO RMS PRECISION RATE SETS
FP-0010004	Infuset-1850	2,089	2,244	25	F2400
FP-0010005	Infuset-930	876	939	25	F1200
FP-0010006	Infuset-820	753	817	25	F900
FP-0010007	Infuset-290	293	305	25	F275
FP-0010008	Infuset-190	189	202	25	F180
FP-0010009	Infuset-650	585	610	25	F600
FP-0010010	Infuset-430	429	444	25	F420/F500
FP-0010011	Infuset-120	122	128	25	F120
FP-0010013	Infuset-45	48	52	25	F45
FP-0010014	Infuset-80	84	87	25	F60
FP-0010027	Infuset-3200	2974	3083	25	-
FP-0010028	Infuset-4000	4084	4254	25	-
FP-0010029	Infuset-4300	4342	4564	25	-

Specific tests were performed confirming that the Infusets can be safely and effectively used with the SCIg60 and the Freedom 60 infusion pump. Flow rates shown above resulted from tests performed using 0.9% saline solution at room temperature in a controlled laboratory setting.

INTENDED USE

Infuset™ Flow Rate Controllers are intended for use with the SCIg60™ Infuser and RMS Freedom 60 Syringe Infusion Pump System to provide flow rate control to administer fluids from a container to a patient's vascular system.

DEVICE DESCRIPTION

EMED Infuset™ Flow Rate Controllers are disposable devices allowing users to obtain a controlled and precise rate of fluid flow when used with the SCIg60™ Infuser or RMS Freedom 60 Syringe Infusion Pump System.

VersaRate[®] and VersaRate[®] Plus

Adjustable Flow Rate Controller

Patent Pending

FLEXIBILITY AND COMFORT WITH ADJUSTABLE FLOW RATE CONTROL

EMED's variable rate control devices, VersaRate[®] and VersaRate[®] Plus are proprietary designs (patent pending) for mechanical pumps with pressure from 5-40+ psi. VersaRate[®] is a flow control device that was originally designed in response to patient and clinician requests to add flexibility to therapies that require flow rate variations during various infusion clinical settings. VersaRate[®] Plus is an adjustable flow rate controller that can be used with the same confidence and simplicity as before - but with added features!

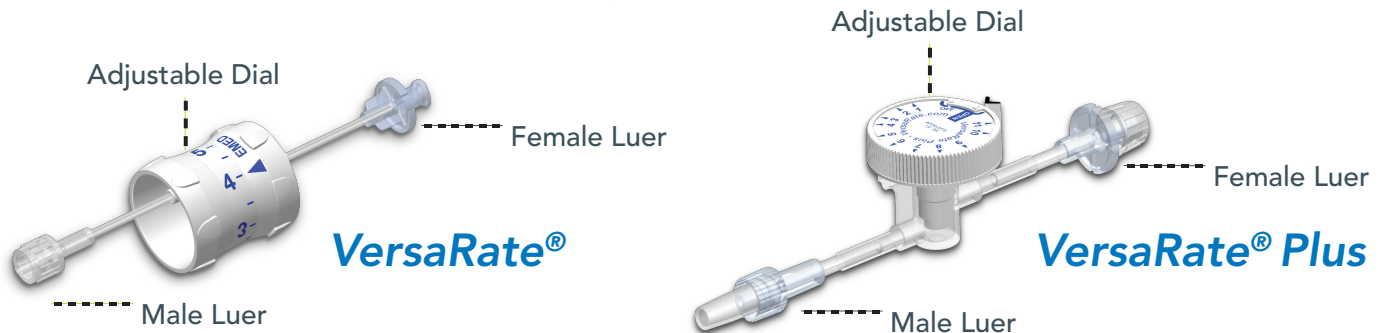

FEATURES	VersaRate [®]	VersaRate [®] Plus
• Can be connected to commercially available administration sets	✓	✓
• Number of flow rate position settings	6	12 with expanded range of flow rates
• Ergonomic design with easy to use dial	✓	Easier to rotate
• Flow stability in a given position setting	✓	✓
• Off position to stop flow immediately, if needed	✓	✓
• Low residual volume	✓	✓
• Includes dedicated flow rate calculator	✓	✓
BENEFITS		
• Adjustable when dynamic conditions require changes in therapy	✓	✓
• Cost effective by eliminating additional combinations of rate control sets	✓	✓
ADVANTAGES		
• Improved flow rate control	✓	✓
• Easier priming	✓	✓
• Manufactured with superior polymers to minimize chemical interaction with pharmaceuticals	✓	✓

Increased Flexibility and Comfort

To optimize patients therapy.

Quick Reference (See instructions for use for complete guide)

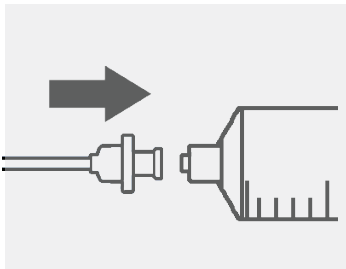

CONNECT syringe male luer lock (MLL) to VersaRate® or Versarate® Plus female luer lock (FLL).

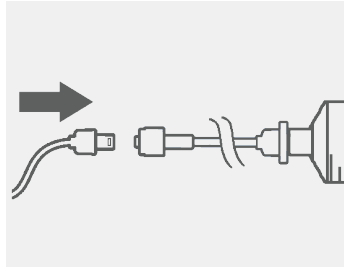

CONNECT VersaRate® or Versarate® Plus male luer lock (MLL) to specified patient administration set female luer lock (FLL).

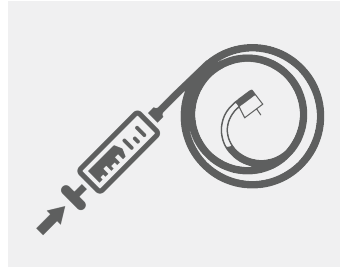

PRIME set (be careful not to waste fluid) as instructed by your healthcare provider.

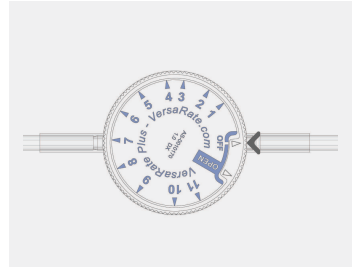

'OFF' POSITION Turn VersaRate® or Versarate® Plus to 'OFF' position. (Versarate® Plus shown)

EMED REORDER NUMBER	ITEM DESCRIPTION	QTY PER BOX
FP-0010003	VersaRate, Adjustable Flow Rate Infusion Set	25
FP-0010026	VersaRate Plus, Adjustable Flow Rate Infusion Set	25

Relative Influence of Factors Causing Variability in Flow Rate during SCIg Treatment

Administration of subcutaneous immunoglobulin (SCIg) with mechanical pumps is affected by several factors including nominal pump pressure, flow rate control tubing design, patient infusion set length, number of infusion sites, ambient temperature, pressure, patient body mass and tissue absorption among others.

Temperature, for example, has a measurable effect on the viscosity of immunoglobulin, and changes in viscosity have a significant effect on flow rate performance. In addition, body mass index and tissue absorption are patient dependent and dynamic factors that also impact flow rates.

The VersaRate® and VersaRate® Plus adjustable flow controller is intended to help offset the variations inherent to patient, setup and environmental conditions by allowing adjustment of flow rate through its dial to meet specific infusion requirements.

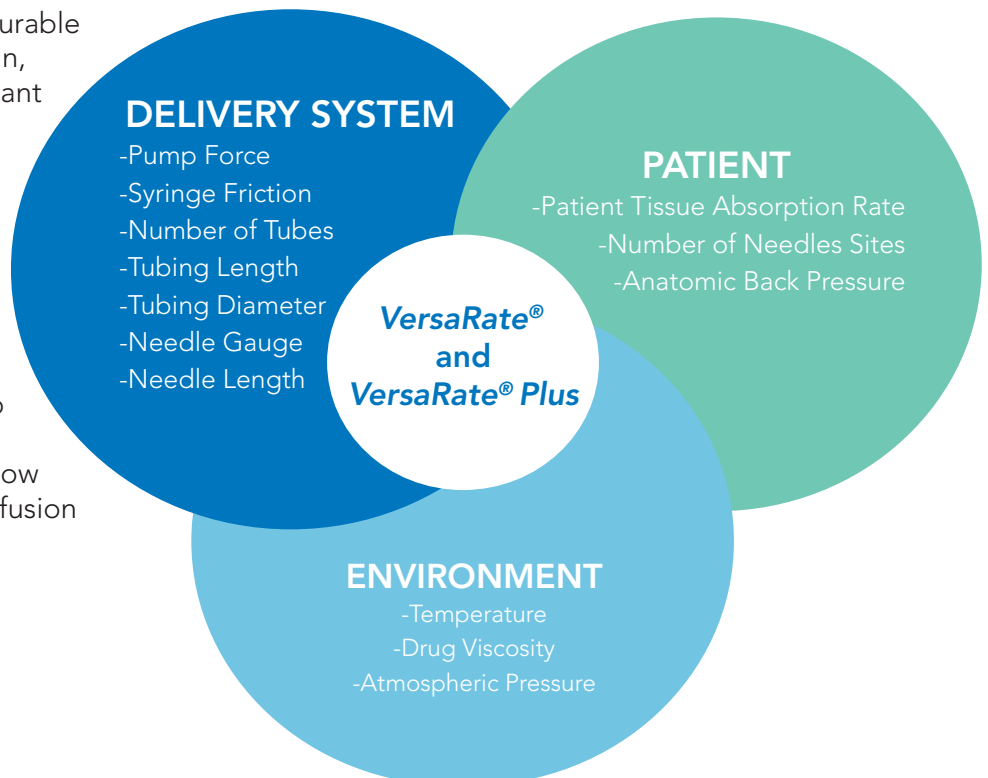

PROPRIETARY NEEDLE DESIGN AND COATING TECHNOLOGY

Working with leading clinicians in the field of immunology to maximize patient comfort and safety, Soft-Glide® SUB-Q administration sets are intended to provide subcutaneous infusion of medicine from an external pump or syringe. They provide comfort with a proprietary needle design and coating technology making needle insertion virtually painless.

Soft-Glide® SUB-Q administration sets have been carefully engineered and developed to create a positive patient experience. This optimized and coated needle bevel design reduces tissue damage and requires minimal insertion force.

The patented wing design protects clinicians and patients after the needle is removed. Soft-Glide® SUB-Q administration sets allow for optimal flow performance with a wide range of fluid viscosities.

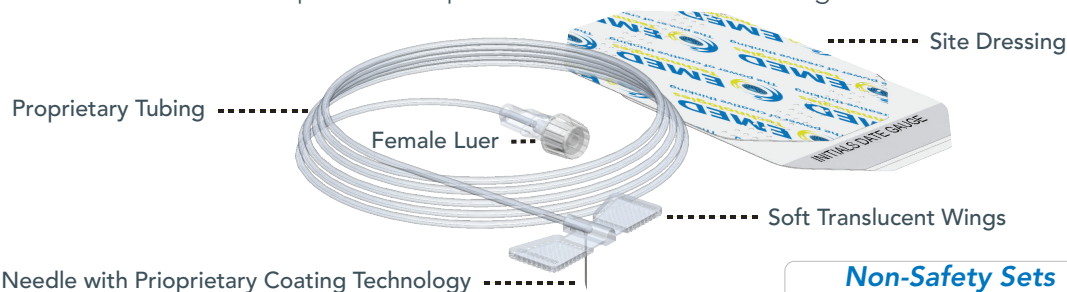

FEATURES

- Coating technology to minimize needle discomfort and anxiety
- The widest selection of single and multi-needle site infusion sets
- Needle lengths: 4, 6, 9, 12 and 14mm to accommodate all age groups and skin types
- Soft translucent wings to facilitate placement and patient comfort
- Proprietary ultra-flexible polyethylene tubing
- Sterile EMED hypoallergenic site dressing for each needle
- Proprietary wing design ensures the needle is enclosed completely and securely

BENEFITS

- Needle insertion is virtually painless
- Requires significantly less penetration force when inserting the needle into the skin
- Maximizes patient comfort throughout the infusion
- Is great for skin-sensitive patients (thin-skinned, older patients and children)

ADVANTAGES

- Optimal flow performance with a wide range of fluid viscosities
- Easier needle insertion with minimization of tissue damage
- Manufactured with superior polymers to minimize chemical interaction with pharmaceuticals
- Facilitates 90 degree insertion
- Studies show Soft-Glide® administration sets outperforms many leading needle manufactures

	Non-Safety Sets SUB Models	Safety Sets SAF-Q® Models
	☑	☑
	☑	☑
	☑	☑
	☑	☑
	☑	☑
	☑	☑
	Not a Feature	☑
	☑	☑
	☑	☑
	☑	☑
	☑	☑
	☑	☑
	☑	☑
	☑	☑
	☑	☑

*If you would like a copy of the needle comparison report please contact sales support.

Increased Safety and Comfort

With Optimal Flow Performance

Ordering Information

For orders and inquiries, contact your local EMED representative or EMED's customer service department at 916-932-0071. Orders can also be placed via email at orders@emedtc.com.

Needle-Free Injection Site*

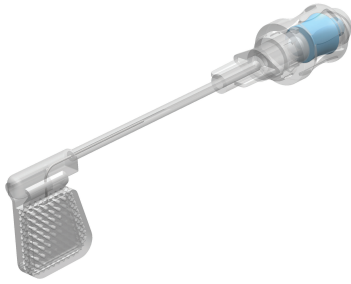

SUB-270 Extension Set



SUB-470 Extension Set



Single Needle Sets

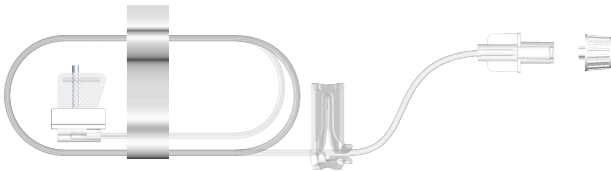

EMED REORDER NUMBER	TUBING LENGTH	NEEDLE LENGTH (mm)	NEEDLE GAUGE	PRIMING VOLUME	BOX QTY
SUB-104-G27	36"	4	27	0.23	50
SUB-106-G27	36"	6	27	0.23	50
SUB-106-G27-70	27.56"	6	27	0.18	50
SUB-106-S	2"	6	27	0.05	50
SUB-106-SNF*	2"	6	27	0.14	50
SUB-109-G24	36"	9	24	0.34	50
SUB-109-G27	36"	9	27	0.23	50
SUB-109-G27-70	27.56"	9	27	0.18	50
SUB-109-G24-12	12"	9	24	0.16	50
SUB-112-G24	36"	12	24	0.34	50
SUB-112-G27	36"	12	27	0.23	50
SUB-112-G27-70	27.56"	12	27	0.18	50
SAF-Q-106-G27	36"	6	27	0.23	50
SAF-Q-106-G24	36"	6	24	0.34	50
SAF-Q-109-G24	36"	9	24	0.34	50
SAF-Q-109-G24-12	12"	9	24	0.16	50
SAF-Q-109-G27-SNF*	2"	9	27	0.14	50
SAF-Q-109-G27	36"	9	27	0.23	50
SAF-Q-106-SNF*	2"	6	27	0.14	50
SAF-Q-106-S	2"	6	27	0.05	50
SAF-Q-112-G24-12	12"	12	24	0.16	50
SAF-Q-112-G27	36"	12	27	0.23	50
SAF-Q-112-G24-70	27.56"	12	24	0.28	50

Bi-Furcated Needle Sets

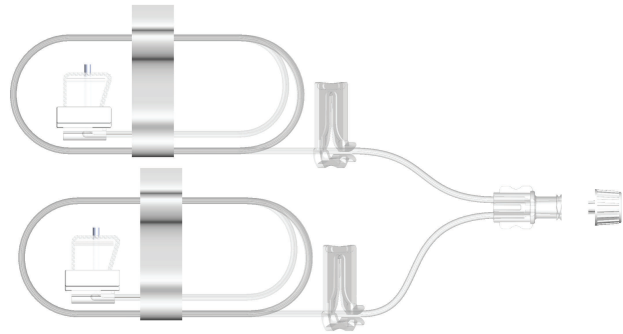

EMED REORDER NUMBER	TUBING LENGTH	NEEDLE LENGTH (mm)	NEEDLE GAUGE	PRIMING VOLUME	BOX QTY
SUB-204-G27	36"	4	27	0.40	10
SUB-209-G24	36"	9	24	0.66	10
SUB-212-G24	36"	12	24	0.66	10
SUB-212-G27	36"	12	27	0.40	10
SUB-250	36"	6	27	0.40	10
SUB-260	36"	9	27	0.40	10
SUB-270	3.5"	n/a	n/a	0.14	10
SAF-Q-206-G27	36"	6	27	0.40	10
SAF-Q-206-G24-70	27.56"	6	24	0.52	10
SAF-Q-209-G24-70	27.56"	9	24	0.52	10
SAF-Q-209-G27	36"	9	27	0.40	10
SAF-Q-212-G24-70	27.56"	12	24	0.52	10
SAF-Q-212-G27	36"	12	27	0.40	10

Coating Technology

Minimize Needle Discomfort and Anxiety

Tri-Furcated Needle Sets

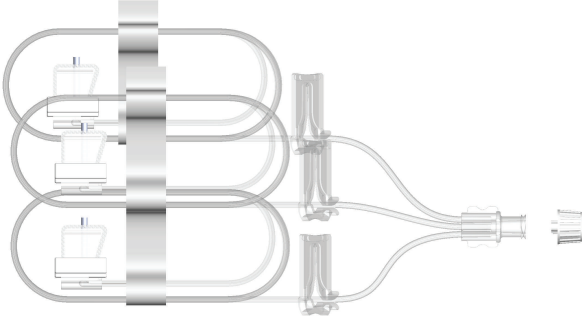

EMED REORDER NUMBER	TUBING LENGTH	NEEDLE LENGTH (mm)	NEEDLE GAUGE	PRIMING VOLUME	BOX QTY
SUB-309-G24	36"	9	24	0.97	10
SUB-310	36"	6	27	0.65	10
SUB-312-G24	36"	12	24	0.97	10
SUB-312-G27	36"	12	27	0.65	10
SUB-320	36"	9	27	0.65	10
SAF-Q-306-G27	36"	6	27	0.65	10
SAF-Q-309-G24	36"	9	24	0.97	10
SAF-Q-309-G27	36"	9	27	0.65	10
SAF-Q-312-G24-70	27.56"	12	24	0.75	10
SAF-Q-312-G27	36"	12	27	0.65	10

Quad-Furcated Needle Sets

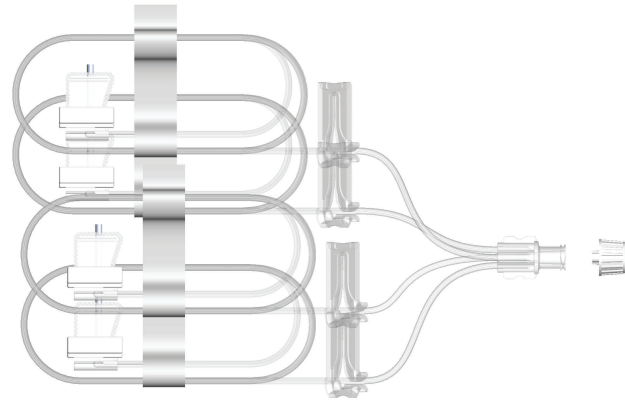

EMED REORDER NUMBER	TUBING LENGTH	NEEDLE LENGTH (mm)	NEEDLE GAUGE	PRIMING VOLUME	BOX QTY
SUB-400	36"	6	27	0.80	10
SUB-409-G24	36"	9	24	1.30	10
SUB-410	36"	9	27	0.80	10
SUB-412-G24	36"	12	24	1.30	10
SUB-412-G27	36"	12	27	0.80	10
SUB-414-G27	36"	14	27	0.80	10
SUB-470	5.5"	n/a	n/a	0.30	10
SAF-Q-406-G27	36"	6	27	0.80	10
SAF-Q-409-G24-70	27.56"	9	24	0.96	10
SAF-Q-409-G27	36"	9	27	0.80	10
SAF-Q-412-G27	36"	12	27	0.80	10
SAF-Q-412-G24-70	27.56"	12	24	0.96	10

Penta-Furcated Needle Sets

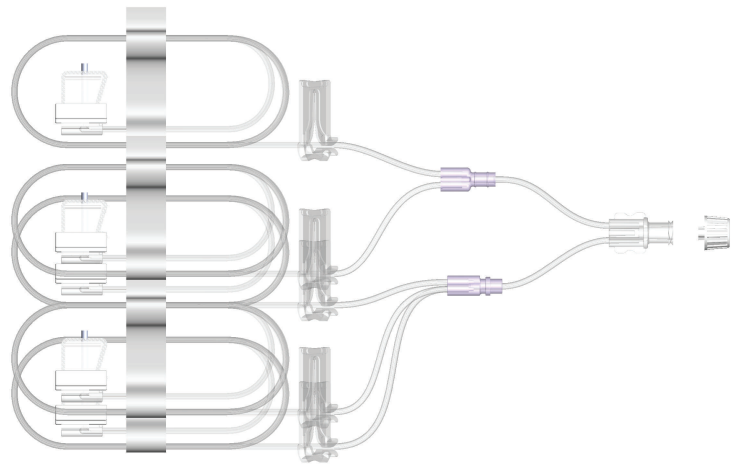

EMED REORDER NUMBER	TUBING LENGTH	NEEDLE LENGTH (mm)	NEEDLE GAUGE	PRIMING VOLUME	BOX QTY
SUB-506	36"	6	27	1.00	10
SUB-509	36"	9	27	1.00	10
SUB-512-G24	36"	12	24	1.57	10
SAF-Q-509-G27	36"	9	27	1.00	10

Hexa-Furcated Needle Sets

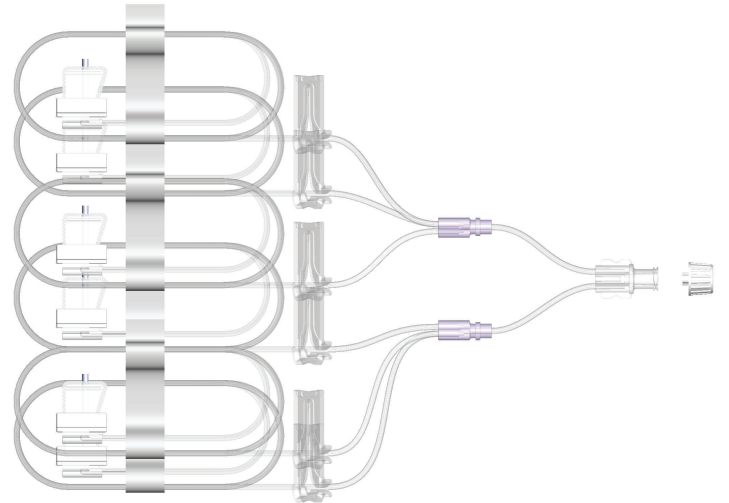

EMED REORDER NUMBER	TUBING LENGTH	NEEDLE LENGTH (mm)	NEEDLE GAUGE	PRIMING VOLUME	BOX QTY
SUB-606	36"	6	27	1.20	10
SUB-609	36"	9	27	1.20	10
SUB-612-G24	36"	12	24	1.87	10
SAF-Q-609-G27	36"	9	27	1.20	10

To place an order, contact EMED Customer Service at 916.932.0071 or via email at orders@emedtc.com.

AccuFlo™

Infusion Sets with precise flow regulator

OPTIMIZED FLOW STABILITY

For use in the administration of I.V. fluids, EMED offers a superior family of precise infusion sets with accurate flow regulation. EMED devices have experienced excellent clinical acceptance and constitute a cost effective alternative to the utilization of infusion pumps.

EMED's flow regulators provide reliable flow rate accuracy while minimizing drifting over time. Their principle of operation incorporates design features that optimize flow stability.

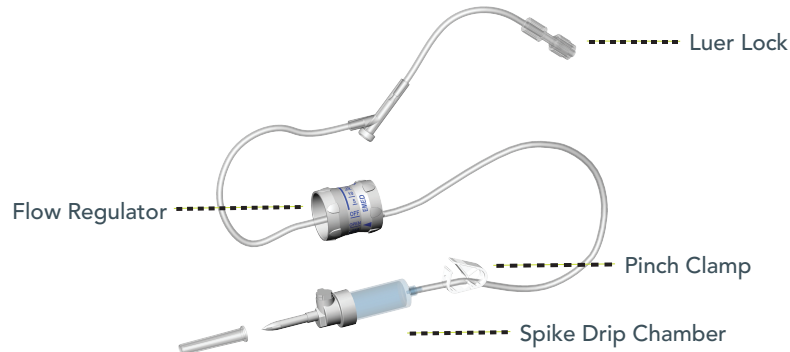

FEATURES

Flow Regulator

- The dial is designed to reduce the event of accidental change of flow rate.
- Flow rates are adjustable from 21-250 ml / hr.

Spike Drip Chamber

- Our infusion sets are available with 20 d/ml universal spike drip chamber and a built in 15-micron particle filter.

Luer Lock

- Our AccuFlo™ infusion sets include high quality swivel male luer locks to facilitate easy catheter connections.

Pinch Clamp

- The pinch clamp provides simplified on/off functionality.

BENEFITS

- Accurate flow control without the use of an infusion pump.
- Improved flow rate stability over 24 - 48 hours of use compared to conventional roller clamps and to other flow regulators.

ADVANTAGES

- AccuFlo sets are non-DEHP and Latex-free
- Fitted with standard "Y" injection ports
- Available with needle-free access ports
- Easy-to-read dial scale
- Ergonomic tactile design with rigs for easy adjustment
- Proprietary pressure rating for special clinical settings
- Custom configurations available upon request

ORDERING INFORMATION

EMED REORDER NUMBER	ITEM DESCRIPTION	PRIMING VOLUME	BOX QTY
FLO-100	92" AccuFlo™ Flow Regulator Infusion Set with injection Site		
FLO-110	18" AccuFlo™ Flow Regulator Extension Set	17.1 ml	50
FLO-120	92" AccuFlo™ Flow Regulator Infusion Set with Needle-Free Injection Site	3.5 ml	50
		16.6 ml	50

www.emedtc.com | sales@emedtc.com

Flow Control

Calculator Tool





FLOW RATE CALCULATOR

EMED's flow rate calculator tool is designed to assist patients and clinicians in the selection of flow rate settings. Based on actual flow rate test data, the flow rate calculator is a combined application referencing each of the flow rate controllers.



FEATURES

- Provide accurate flow rate estimates based on laboratory testing with viscous fluids.
- User-friendly interface with easy selection of different drugs, infusion pumps and administration sets.
- Provides clear warnings based on drug prescribing information.
- Runs directly in MS Excel, no installation needed
- Summarizes selection options and flow rate results in a separate easy-to-print format
- Visit www.versarate.com to use the all in one easy-to-use application.

Infusion Results		
	Total Flow Rate	27 ml/hr
	Flow Rate Per Site	14 ml/hr
	Volume Per Site	12.5 ml
	Expected Duration	0 hrs 55 min



The power of creative thinking

1262 Hawks Flight Court, Suite 200, El Dorado Hills, CA 95762 USA

TELEPHONE: 916.932.0071 | FAX: 916.932.0074

www.emedtc.com | sales@emedtc.com

MM-061_1.1

USA, EU, CA