

# Avoset Infusion Pump

## User Manual



## Copyright and Trademarks

Copyright © 2023 Eitan Medical LTD. All rights reserved. The design, pumping mechanism, and other features of the Avoset Infusion Pump are protected under one or more US and Foreign Patents.



15132-048-0003 | Rev2.0Ver02 / 02.2023

eng



**Eitan Medical LTD**

29 Yad Haruzim St.

P.O. Box 8639

Netanya 4250529

ISRAEL

+972-73-238-8888

[support@eitanmedical.com](mailto:support@eitanmedical.com)

### **Technical Assistance**

For technical questions and troubleshooting assistance please contact your local agent/distributor or contact us via email: [support@eitanmedical.com](mailto:support@eitanmedical.com) or toll-free number +1.877.541.9944 (see the website [www.eitanmedical.com](http://www.eitanmedical.com) for other numbers that may be available)

### **Serious Incident Reporting**

Any serious incident that has occurred in relation to the device should be reported to [complaints@eitanmedical.com](mailto:complaints@eitanmedical.com) and to the local competent authority.

### **Bluetooth License**

Avoset is qualified under Bluetooth SIG and has licensee right to use the Bluetooth trademarks.

## Terms and Conditions

The Avoset Infusion Pump User Manual is delivered subject to the conditions and restrictions listed in this section. Clinicians and qualified hospital staff should read the entire User Manual prior to operating the Avoset Infusion Pump in order to fully understand the functionality and operating procedures of the pump and its accessories.

- Healthcare professionals should not disclose to the patient the pump's security code or any other information that may allow the patient access to restricted programming and operating functions.
- Improper use may cause injury or death to the patient.
- All users of the Avoset Infusion Pump should be instructed on the proper use of this pump and accessories. Contact Eitan Medical or your local agent/distributor for training.
- The pump's warranty will be null, and void and the manufacturer will assume no responsibility for incidents which may occur if the product is not used in accordance with product labeling and documentation.

Contact your local agent/distributor as needed.

## Prescription Notice

Federal United States law restricts this device for sale by or on the order of a physician only {21CFR 801.109(b) (1)}.

The Avoset Infusion Pump is for use at the direction of, or under the supervision of, licensed physicians and/or licensed healthcare professionals who are trained in the use of the pump and in the administration of parenteral and enteral infusions. The instructions for use presented in this manual should in no way supersede established medical protocol concerning patient care.

# Table of Contents

<b>Table of Contents</b> .....	<b>3</b>
<b>Chapter 1: Introduction</b> .....	<b>1</b>
Product Description.....	1
Intended Use.....	1
Indications for Use .....	1
Overview .....	1
About This Manual .....	3
Disclaimer.....	3
Intended Audience.....	3
Document Conventions.....	3
Warnings and Safety Precautions .....	5
Pump Safety .....	5
Proper Use of the Equipment .....	7
Pediatrics.....	10
<b>Chapter 2: Getting Started</b> .....	<b>12</b>
Product Overview .....	12
Pump User Interface .....	12
Display Orientation .....	13
First Time Usage/Visual Inspection.....	14
Installing Batteries .....	14
Powering ON/OFF .....	15
<b>Chapter 3: Accessories</b> .....	<b>17</b>
Administration Sets .....	17
Attaching the Administration Set.....	18
Removing an Administration Set from the Pump.....	19
The Cassette Lock.....	19
Attaching the Cassette Lock.....	20
Removing the Cassette Lock .....	20
The Cradle.....	21
<b>Chapter 4: Setting Up an Infusion</b> .....	<b>23</b>

Introduction.....	23
Determining the Medication Container .....	23
IV Bag .....	23
Syringe.....	24
Medication Reservoir (pre-filled cartridge) .....	24
Priming the Administration Set .....	25
Automatic Priming .....	25
Manual Priming.....	26
Reviewing Parameters.....	27

## **Chapter 5: Basic Functions ..... 28**

Starting an Infusion .....	28
Starting.....	28
Pausing .....	29
Delaying the Start.....	29
Ending an Infusion .....	29
Without KVO .....	29
With KVO.....	30
Turning Off (shutting down) the Pump.....	30
Password Protection .....	31
Pairing with the AvosetGo Mobile App.....	32

## **Chapter 6: Program Types ..... 33**

Introduction.....	33
Identifying the Current Program Type .....	33
Viewing and Editing Parameters .....	34
To view: .....	34
To edit: .....	34
Parameter Values.....	35
Additional Program Information .....	39
Intermittent.....	39
Taper .....	41
Patient Controlled Analgesia (PCA) Mode .....	41
Continuous .....	44

## **Chapter 7: Maintenance..... 45**

Cleaning and Disinfecting .....	45
---------------------------------	----

Cleaning the Pump .....	46
Disinfecting the Pump .....	46
Cleaning the Accessories.....	46
Disinfecting the Accessories.....	47
Maintenance (Visual Inspection).....	47
Optional Testing .....	48
Required Equipment .....	48
Delivery Accuracy Test .....	49
Occlusion Detection Test .....	49
Air Detection Test .....	50
Transportation and Storage .....	51
<b>Chapter 8: Alarms (Troubleshooting) .....</b>	<b>52</b>
Alarm Priority .....	52
Responding to Alarms .....	53
<b>Appendix A: Technical Specifications .....</b>	<b>56</b>
Specifications.....	56
Operation Conditions .....	57
Pump Accuracy .....	58
Post-Occlusion Time and Volume .....	60
Start-up and Trumpet Graphs .....	61
Advanced Settings .....	66
General Settings .....	66
Password Protection Settings .....	67
Program-specific Settings.....	67
Event Log .....	70
<b>Appendix B: Safety and Compliance.....</b>	<b>71</b>
Compliance and Classification.....	71
Electromagnetic Compatibility Statement .....	71
Identification Numbers .....	74
Class B Warnings .....	74
Modification Statements and FCC/ ISED Regulatory Notices .....	75
Electromagnetic Emission .....	76
Electromagnetic Immunity.....	76
Applicable IEC Classifications .....	80
Other Compliance .....	80



# Chapter 1: Introduction

## Product Description

### Intended Use

The Avoset Infusion Pump is a single-channel, volumetric infusion pump. Medication is delivered at continuous rate, and/or with an intermittent bolus, and/or with a patient bolus and/or with taper.

### Indications for Use

<b>Routes</b>	Parenteral (intra-arterial, intra-venous, subcutaneous, perineural , epidural), and enteral infusions.
<b>Patient Populations</b>	Pediatric (infants, children and adolescents) and adult patients.
<b>Fluids</b>	IV medication (including fluids), Total Parenteral Nutrition (TPN), Enteral nutrition, lipids Epidural medication.
<b>Program Types (specific uses)</b>	The pump delivers in one of four program types: a continuous rate of infusion, and/or an intermittent bolus, and/or with patient-controlled intermittent doses, and/or with tapering.
<b>Intended Environments</b>	Intended to be used in clinical environment and ambulatory environment including, home, plane and ground transportation
<b>Users</b>	licensed health care professional and lay users

The dedicated Administration Sets for the Avoset Infusion Pump are intended for single-patient use and single-use only. Set configurations are: (i) Enteral; (ii) Epidural and (iii) General purpose for the balance of the routes: intra-arterial, intra-venous, subcutaneous, perineural.

The Avoset Programming Tool is intended to be used with a computer to create a treatment-based protocol that is loaded onto the pump. The programming tool is intended for use by professional users.

### Overview

The Avoset Infusion Pump is a compact, ambulatory (home, plane and ground transportation) pump that provides controlled infusions.

The pump is pre-programmed via the Avoset Programming Tool, a dedicated PC application. The clinician uses the Programming Tool to set up a pump for an infusion treatment for a patient. Working on a PC's large screen size provides a convenient and efficient way to define an infusion program and the pump settings. The infusion program and the pump settings are then transferred (downloaded) to the pump via the AvosetPad, a device provided by Eitan Medical that uses Bluetooth and near-field communication to connect the pump and the PC. The patient receives the pump preprogrammed for their specific infusion and limited editing of the infusion program parameters is allowed on the pump itself.

The pump can connect via Bluetooth to a dedicated mobile phone application in order to pass the pump progress events to the Insights Tool. The Insights Tool is a cloud-based platform that includes modules for pump fleet management and treatment monitoring, which are not covered in this user manual.



# About This Manual

## Disclaimer

The information in this manual has been carefully examined and is believed to be reliable. No responsibility is assumed for any inadvertent inaccuracies. Eitan Medical reserves the right to make changes to any of its products in order to improve reliability, design and performance. The instructions presented in this manual should in no way supersede established medical protocol concerning patient care. The text and drawings herein are for the purposes of illustration and reference only; the specifications on which they are based are subject to change without notice.

## Intended Audience



This manual is intended for use by medical professionals. Clinicians and medical technicians using the device should read this user manual prior to operating the Avoset Infusion Pump to make sure they fully understand the functionality and operating procedures of the pump and its accessories.

Patients (for home use), or any person who will be assisting the patient (for example, family members), must be trained in the proper use of the pump. As part of their training, patients will be provided with written material specific to their infusion. They may also access this user manual if they desire.

## Document Conventions

### Information Identification Symbols

The following symbols indicate hazard or special information:

	<b>Warnings</b> indicate precautions and instructions which, if not followed, may result in personal injury.
	<b>Cautions</b> indicate instructions which, if not followed, may result in damage to the equipment or to the quality of treatment.
	<b>Notes</b> provide additional information to help obtain optimal equipment performance.

## Interface Notation

In this manual, text that appears on the pump screen is shown like **THIS**.

**Example:** The pump displays the flashing message **BOLUS DELIVERING**.

Physical buttons and controls are shown like **THIS**.

**Example:** Press **PRIME**.

The two multifunction buttons  are used to respond to instructions on the screen. Their function depends on what is on the screen at the moment.

**Example:** Press  [CONFIRM]

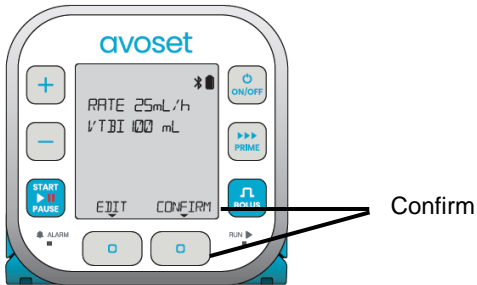

## Terms and Abbreviations

Term	Definition
AFFV	Anti-Free-Flow Valve
BLE	Bluetooth Low Energy
DC	Direct Current
DFU	Directions for Use
EMC	Electromagnetic compatibility
EMI	Electromagnetic Interference
KVO	Keep Vein Open
ME	Medical Equipment
mg	milligram
mL	milliliters
MRI	Magnetic Resonance Imaging
NFC	Near Field Communication
PCA	Patient Controlled Analgesia
Rate	The amount of fluid infused in an hour
RF	Radio Frequency
VI	Volume Infused (the amount of volume already infused during the current infusion)
VTBI	Volume to Be Infused (the amount of fluid programmed or remaining to be infused)

# Warnings and Safety Precautions

Familiarize yourself with all safety information in this manual and any additional instructions accompanying the disposables and accessories before using the pump.

## Pump Safety

### General Warnings and Cautions

---



#### Warning

- The device is not intended for the delivery of blood or cellular blood products.
  - Do not use the pump if it has been dropped or appears to be damaged until it has been inspected by trained and qualified technical personnel.
  - Do not attempt to modify the pump or accessories.
  - Do not attempt to disassemble any part of the pump mechanism or housing.
  - Keep the pump and accessories away from pests, pets, and unattended children.
- 
- 



#### Caution

- Avoid exposure to sun and excessive heat.
  - Avoid exposure to steam and boiling water.
  - Avoid contact with lint and dust.
  - Do not submerge or expose to running water.
  - Avoid pressing on the screen or controls with excessive force.
  - Avoid locations with large temperature fluctuations. If the pump is moved to a location with a great temperature difference, do not operate immediately. Allow it to adjust to the new temperature. For more information about proper operating conditions, see *Operation Conditions* on p. 57.
- 
- 

### Waste Disposal Warnings and Cautions

---



#### Warning

- Keep used plastic infusion containers, packaging, and tubing out of the reach of children.
  - Do not dispose of the battery in or near fire (see *Recycling & Disposal* on p. 80).
-



### Caution

- Dispose of the packaging, the administration sets, the battery, the cradle, the Cassette Lock, and any other electronic components in accordance with applicable environmental laws (such as the WEEE Directive for Waste Electrical and Electronic Equipment). Contact your local authority to determine the proper method of disposal.
  - Dispose of administration sets properly, based on possible residual, in accordance with local disposal guidelines.
- 

## Explosion Warnings

---



### Warning

Do not use the pump in the presence of flammable anesthetic mixture with air or with oxygen or nitrous oxide.

---

## Electric Shock Cautions

---



### Caution

There is no direct risk of electric shock. However, only fully trained and qualified service technicians should access any internal part of the pump.

---

## Proper Use of the Equipment

### Pump Integrity Warnings

---



#### Warning

- **Intended Purpose:** Do not use the pump for anything other than its intended purpose. Misuse of the pump may result in pain, exacerbation of illness, injury or harm, stroke, electrocution, exsanguination trauma, or death. Although the Avoset Infusion Pump has been designed and manufactured to exacting specifications, it is not intended to replace trained personnel in the monitoring of infusions.
  - **Approved Accessories:** Use only Eitan Medical approved accessories with the pump.
  - **Approved Administration Sets:** Use only Eitan Medical administration sets with the pump (see the website [eitanmedical.com](http://eitanmedical.com) for updated information about approved sets). The use of unsuitable administration sets could impact the function of the pump.
  - **Approved Liquids:** Use only liquid products that are approved by the FDA (or applicable regulatory agency in your region) with the pump.
  - **Interface Performance:** Do not use the pump if its interface (including screen messages, audible signals, or physical key functions) do not perform as described in this manual.
  - **Infusion Site:** Verify the proper route of delivery and the patency of the infusion site before beginning an infusion.
  - **Monitoring Patients:** Monitor patients periodically (based on clinical practice) to ensure that the infusion is proceeding as expected. For home users in an ambulatory environment (home, plane and ground transportation), monitoring may be provided by a visiting or on-call nurse, or training of patient or relative, based on suitable clinical practice.
  - **Training Patients:** Home users and their care-givers must be trained before using the pump.
  - **No Modification:** Do not attempt to disassemble or modify the pump.
  - **Additional Pump:** Provide patient with an additional pump if the treatment is for life-sustaining medication; in addition, close supervision and provision for immediate corrective action should be provided to assure minimum medication delivery interruption in the event of a pump failure
-

## Administration Set Warnings and Cautions

---



### Warning

- **Disconnect:** Do not connect the administration set to the patient while priming.
- **Avoid Force:** Do not use force when connecting the administration set to the patient.
- **Reading Instructions:** Always read and follow the instructions in this User Manual, and the instructions accompanying the administration set and source container. Carefully follow any label instructions for loading, removing, and reloading the set, as well as the recommended set change interval.
- **Replacing Administration Sets:** Replace the administration set as needed to avoid fluid contamination problems. Follow the policy of infection control and treatment protocol from your facility, the local Centers for Disease Control and Prevention (CDC), and the instructions provided with the administration set.
- **Duration:** Do not use any disposable components (administration sets, etc.) for longer than 96 hours. If you program rate, dose, or bolus combinations which exceed a 96-hour schedule, make sure to replace the administration set on time
- **Proper Handling:** Do not place the administration set on the floor, or in any other location where it can accidentally be damaged, or pose a risk of strangulation, particularly due to excessive length.
- **Damaged or Expired:** Do not use a damaged or expired administration set or damaged set components or packaging.
- **No Re-use:** Do not sterilize Avoset administration sets or clean them for re-use. The sets are for single patient use only. To prevent cross-contamination between patients, never reuse administration sets.
- **Use of Clamps:** Always use the clamps on the administration set to occlude the administration set prior to removing the administration set from the pump.
- **No Modification:** Do not attempt to disassemble or modify an administration set.



### Caution

- **Excessive Force:** Do not apply pressure or pressurized air to any outlet or tubing connected to the pump or to the infusion container. Pressure may destroy sensitive elements.
  - **Handling Tubing:** Do not pull or stretch the tubing in any section of the administration set when the pump is in use.
-

## Occlusion Pressure Alarm Setting Cautions

---



### Caution

- Infiltrations or extravasations will not trigger an alarm, although the pump is designed to stop fluid flow when an alarm occurs.
  - Do not fail to review Low Occlusion sensitivity settings, which may affect the time for occlusion detection. Make sure that the occlusion pressure is set according to the clinical use case. For details, see *Appendix A: Technical Specifications*.
- 

## Air Detection Warnings

---



### Warning

- To prevent patient injury, do not disable air detection for use with Avoset administration sets that do not contain an air-elimination filter (see package labeling). Air detection is an important safety feature of the Avoset Infusion Pump. Disabling the air detection interferes with the pump's ability to alert for hazardous situations. As pediatric populations may be more sensitive to air, take appropriate medical measures when setting air detection level for such populations.
  - Do not start an infusion with an unprimed administration set.
  - Do not infuse non-epidural drugs into the epidural route.
-

## Pediatrics

Specific device features and settings should be used to address the sensitivities of pediatric patients. It is recommended to use one or more of these features, as clinically applicable:

### 1. Air Embolism prevention

Air detection is an important safety feature of the Avoset system. When working with a population with higher sensitivity to air embolism consider using the following:

- a. Administration Set with a Filter – The Filter helps prevent air embolism.
- b. Configuration (for Air in Line detection) - Highly sensitive options for air in line detection are available - select the applicable lower values of the single bubble detection: 0.1, 0.2, 0.5 or 2mL.



#### Warning

As pediatric populations may be more sensitive to air, take appropriate action when setting the air detection level. Do not start an infusion with an unprimed infusion set.

---



#### Caution

To prevent air bubbles from reaching the patient, use an extension set with a minimal priming volume (if applicable).

---

### 2. Dose Errors

- a. **Unintended Bolus.** Infusion sets with large priming volumes increase the risk of inadvertent, delayed bolus effects. To minimize the risk of overdose from an unintended bolus after occlusion to sensitive pediatric populations, consider using the following:
  - i. Administration sets with Microbore tubing
  - ii. Configuration – Sensitive occlusion detection settings - select the applicable lower values of the occlusion detection: 0.5, 1.2 or 1.6bar.

When using microbore tubing and configuring the device to 0.5bar for occlusion detection, the maximum bolus volume will be 0.06. See “Appendix A: Technical specifications”: “Bolus after occlusion” table (shows the correlation between the occlusion detection setting, set choice and maximum bolus volume to be generated.)

- b. The Lowest Aliquot the pump can deliver is  $\sim 1/24$  of its drop size ( $\sim 4\mu\text{L} = \sim 100$  drop size/24).

### 3. Design and performance of administration sets.

Since pediatric patients may be especially active, it is recommended to use microbore sets - these sets protect from kinking during use.



#### 4. Viscosity of fluids

The pump system can deliver all intended fluids, including the more viscous infusates used for feeding therapy, including nutritional formulas and supplements, with different consistencies and viscosities. The device is capable of delivering feeding infusates, which tend to have higher viscosity, via both: (i) Enteral; and (ii) Parenteral routes in the categories listed below:

Type of Delivered Infusate	Enteral route		Parenteral route
	Nutritional formula	Medications	Nutritional formula
Category name	Ready mix	Enteral drug	TPN (with composition of lipids and amino acids)

Consult the “impact of viscosity” graph in “Appendix A: Technical Specifications”. It shows the accuracy impact when considering infusate viscosity and rate (the different combinations of rate and viscosity that will maintain a delivery accuracy of  $\pm 5\%$ ).

#### 5. Routes.

The device is designed to support all indicated routes: Parenteral (intra-arterial, intra-venous, subcutaneous, perineural, epidural and intraoperative site) and enteral infusions. As each route has been validated to maintain accuracy under worst case clinical configurations for adults, the results are also valid for pediatrics which are characterized by lower volumes and lower delivery flow rates, thus presenting lower challenge to the pump performance.

6. Information and Warnings in this section are in addition to other corresponding information within the User Manual. Warnings in the other sections are equally applicable to the pediatric population.

# Chapter 2: Getting Started

## Product Overview

### Pump User Interface

The pump user interface includes the screen, operation buttons, LED indicators, the administration set cassette socket, the administration set release latch, and the battery compartment release latch.

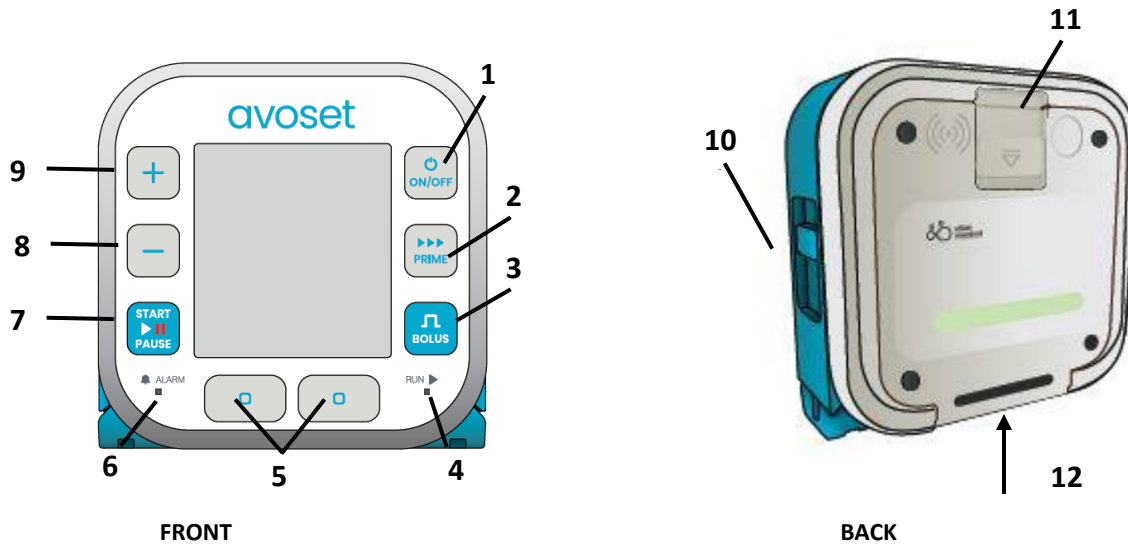

Key	Control Name	Function
1	ON/OFF	Turns the pump ON and OFF.
2	PRIME	Starts the automatic priming procedure to fill the administration set with fluid and expel air.
3	BOLUS	Starts a PCA dose.
4	RUN indicator	Flashes green when pump is running.
5	Multi-function button	Performs the function indicated by the text that appears on the screen above the corresponding button.
6	ALARM indicator	When an alarm appears, flashes yellow for low-priority alarms and red for high-priority alarms.
7	START/PAUSE	Starts or pauses infusion.
8	MINUS	Decreases value when entering amounts (rates, volumes, times, etc.).
9	PLUS	Increases value when entering amounts.
10	Administration set release latch	Releases the administration set from the pump.
11	Battery compartment release	Opens the battery compartment.
12	Cassette socket	Bottom of pump where the administration set cassette attaches to the pump.

## Display Orientation

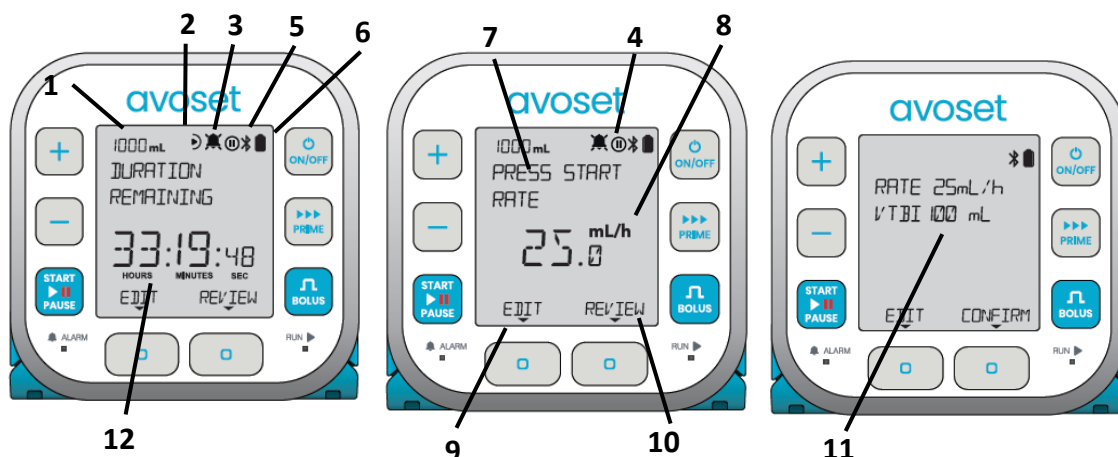

Key	Display Element / Icon	Indication
1	VTBI	Displays the remaining volume to be infused.
2	Running	Running: (spins during infusion).
3	Alarm	indicates an active alarm. indicates paused alarm audio. See <i>Chapter 8: Alarms (Troubleshooting)</i> on p. 52.
4	Paused	Flashes when pump operation is paused.
5	Bluetooth connection	the pump is ready to be paired (displays for first 2 minutes after pump is turned on). the pump is paired.
6	Battery status	Indicates the current battery level. batteries are full. batteries are low. 3-minute warning: batteries are depleted.
7	Text	Displays text, such as system messages, prompts and medicine names.
8	Units of measurement	Indicates the parameter's units of measurements.
9	Left multifunction button label	Text that appears on the screen above a multifunction button, showing the current function of that button (what the button does when pressed).
10	Right multifunction button label	
11	Numeric value	Shows the value of the parameter currently on the screen.
12	Time	Indicates units of measuring time.

## First Time Usage/Visual Inspection

1. Examine the pump. Look for cracks in the casing, screen, battery compartment, and external parts of the pumping area (particularly the cassette socket).
2. Examine the administration set and/or medication reservoir.



### Warning

Do not use the pump, administration set, or medication reservoir if they appear damaged in any way. If in doubt, contact your service provider or Eitan Medical.

## Installing Batteries

The pump is powered by three Alkaline/LRG (AA, 1.5V) or NiMH/HR6 (AA, 1.2V) batteries. MN1500 and DX1500 are batteries that have been tested and approved for use. Check the list of other supported batteries at [eitanmedical.com](http://eitanmedical.com), as this list may be updated.

1. Turn the pump OFF by pressing and holding down **ON/OFF** for 3 seconds.

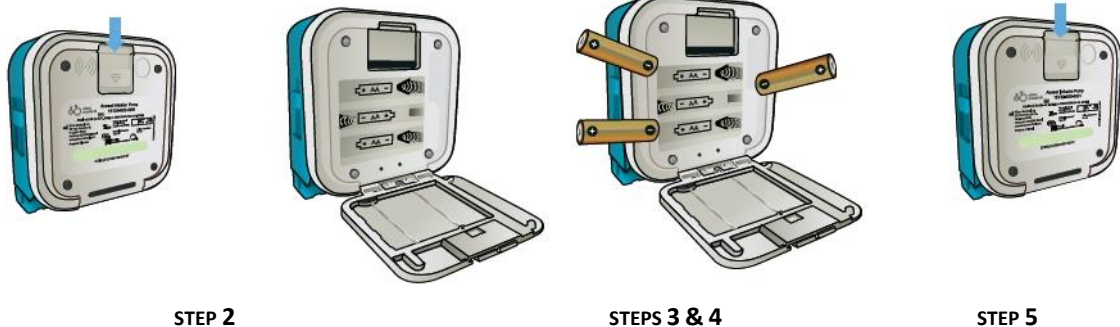

2. Open the battery compartment located at the pump's rear by sliding the latch downwards.
3. Remove depleted batteries from the compartment from the PLUS end, opposite the compartment's spring, to avoid damaging the spring.



### Caution

Dispose of the depleted batteries in accordance with local environmental guidelines.

4. Install new batteries according to the plus/minus orientation illustration inside the compartment.
5. Close the battery compartment.



### Warning

- Keep a new set of 3 AA batteries available for replacement. If power is lost and the treatment of life sustaining medication is stopped then death or serious injury to the patient may occur.
  - Always start a new infusion with fresh set of batteries.
- 



### Note

- If using rechargeable batteries, recharge them using an off-the-shelf dedicated charger, in accordance with the charger manufacturer's guidelines.
  - In the event that the batteries are dislodged during use, the pump includes a backup power source to save settings and provide an alarm.
- 



### Caution

- Never remove the batteries while infusion is in progress!
  - Do not use Lithium batteries and any other unauthorized batteries.
  - Do not replace some batteries (always replace all batteries at once); do not mix new batteries with old ones.
  - Do not install different types of batteries together. Installing different types (for example, rechargeable with alkaline) may affect the pump's performance.
  - Do not insert batteries before visually inspecting the battery compartment for liquid or debris and cleaning it if necessary.
  - Do not store the pump for a prolonged period with the batteries installed.
  - Do not open the battery compartment unless actively changing batteries. (Keep it closed during use.)
  -
- 

## Powering ON/OFF

### To turn on:

1. Press the **ON/OFF** button.

As the pump performs an automatic system check, verify that:

- The LCD screen lights up.
- All areas of the screen are visible, with no stripes or dead pixels (black or white areas covering part of the screen).

- The pumps beeps.
  - The green LED Run indicator turns on.
  - The LED Alarm indicator turns on (first yellow and then red).
  - The pump's serial number and software version appear briefly.
- 



### Caution

Do not use the pump if any of the above checks don't function.

---

2. Respond to the onscreen prompts (see *Chapter 4: Setting Up an Infusion* on p. 23).

### To turn off:

1. If the pump is running, press **PAUSE**.
2. Press and hold down **ON/OFF** for 3 seconds.  
The pump turns OFF.

### To stop an infusion in an emergency:

1. Disconnect the administration set from the pump.  
This automatically pauses infusion. The administration set automatically clamps and stops the flow of fluid to the patient.
  2. Press and hold down **ON/OFF** for 3 seconds.
- 



### Note

The pump turns off and the settings are saved.

---

# Chapter 3: Accessories

The Avoset Infusion Pump is provided as a single unit with this user manual. The following accessories are provided separately:

- Administration set: the single-use disposable part that connects the infusion liquid to the pump
- Cradle: external holder to attach the pump to an IV pole
- Cassette Lock: transparent secure cover to prevent unauthorized users from disconnecting the medication reservoir from the pump

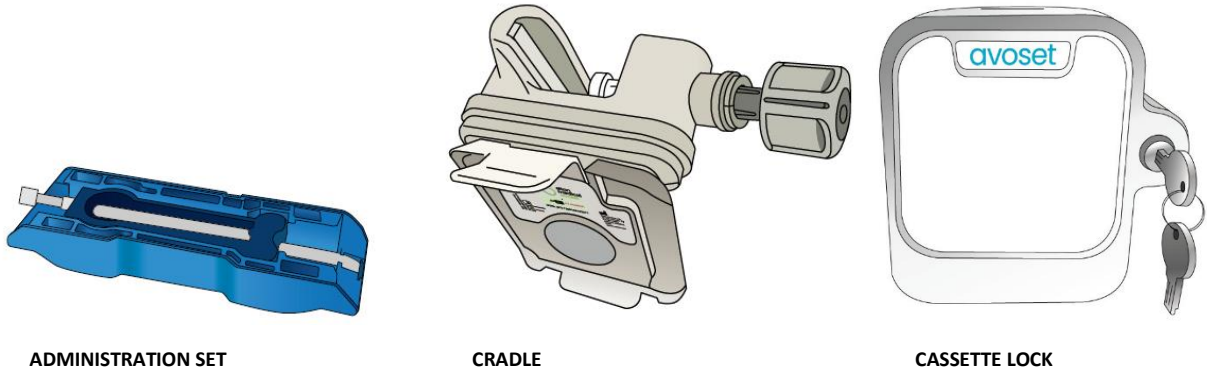

## Administration Sets

The pump can only operate with the Avoset administration set, which connects the infusion tubing to the pump.

This administration set includes an Anti-Free-Flow Valve that is closed when the AFFV release clip is removed to protect against accidental fluid flow. Opening the valve allows manual priming.

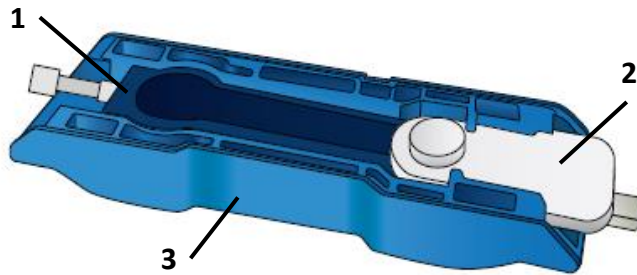

Key	Component Name	Function
1	AFFV (Anti-Free-Flow Valve)	Allows/prevents fluid flow through the set. When pressed (by hand or clip), the valve is open; when released, the valve is closed.
2	AFFV release clip	Keeps the AFFV open while the set is packaged or before attaching the administration set to the pump.
3	cassette	The entire piece is the cassette, which is what connects to the pump.

## Attaching the Administration Set

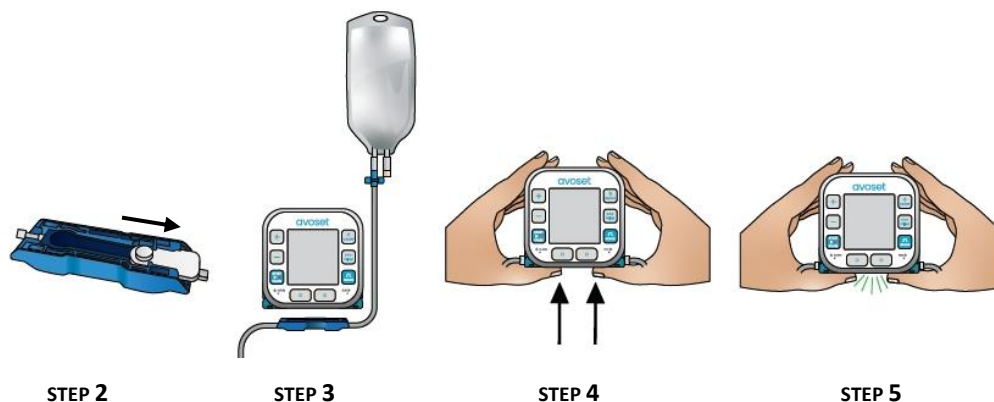

1. Visually inspect the packaging for breaches of integrity prior to use.



### Warning

Do not use an administration set if the packaging appears damaged in any way.

2. Remove the AFFV release clip from the new administration set cassette.
3. Position the cassette at the bottom of the pump with the infusion bag on the right side. The flow direction arrow points left, relative to the pump front.
4. Push the cassette into the pump's cassette socket.
5. You should hear 2 clicks to indicate that the cassette is fully attached. Verify that it is securely attached.
6. Open all clamps on the new administration set.



### Note

The medication reservoir is attached and released by following the same procedures.



### Warning

- To prevent unmonitored free-flow of fluids into the patient, always clamp the administration set before releasing a used administration set cassette from the pump, and before installing a new one.
- Never remove the set clamp until the administration set has been connected to the pump.
- Attach the administration set cassette to the pump before connecting it to the patient.



## Removing an Administration Set from the Pump



1. Close all clamps on the used administration set.
2. Disconnect the patient from the administration set.
3. Push down the **RELEASE SLIDE** on the pump's side.
4. The used administration set cassette is released.
5. Dispose of the used administration set in accordance with local biohazard disposal guidelines.

## The Cassette Lock

The Cassette Lock is a transparent secure cover that prevents interference with a medication reservoir, while allowing access to the pump controls and the battery compartment. It can be used with the cradle.

Each Cassette Lock is provided with two keys that are unique to that Cassette Lock.

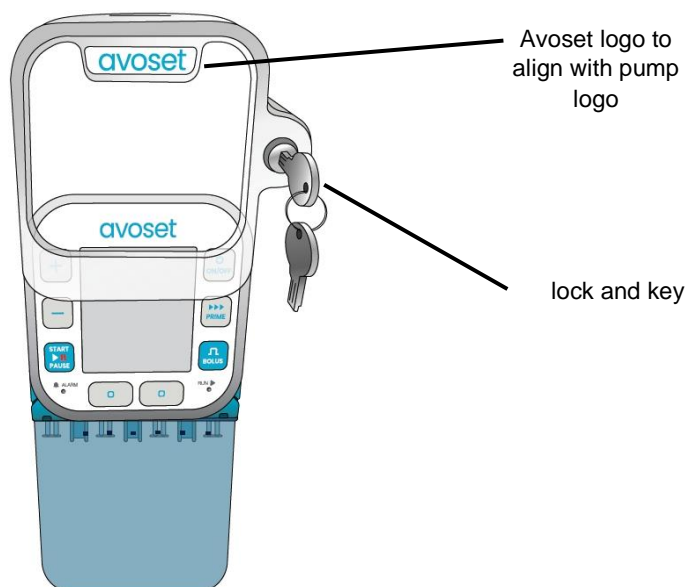

## Attaching the Cassette Lock

1. Visually inspect the Cassette Lock for any cracks.



### Warning

Do not use the Cassette Lock if there appears to be any damage.

2. Make sure that the medication reservoir is correctly installed. It attaches the same way as an administration set (see *Attaching the Administration Set* on p. 18).
3. Insert key and turn counterclockwise to unlock (key position is vertical).
4. Slide the Cassette Lock over the pump so that the Avoset logos line up.

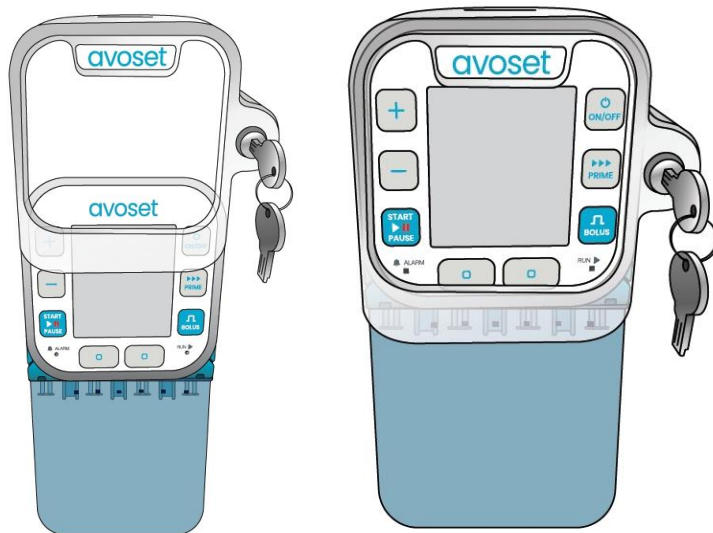

5. To lock, press the key in firmly and turn clockwise (key position is horizontal) and remove. The key can only be removed if the Cassette Lock is locked.



### Note

If performing automatic priming, the Cassette Lock may be attached before priming.

## Removing the Cassette Lock

1. Insert the key. Push in firmly and turn left.
2. Slide the Cassette Lock up, removing it from the pump.



### Note

For cleaning instructions, see *Cleaning the Accessories* on p. 46.

# The Cradle

The cradle is to attach the pump to an IV pole or bed rail. It can be attached vertically or horizontally. Once attached, the cradle can be rotated vertically or horizontally to keep the pump display conveniently oriented.

Always attach the cradle first before inserting the pump into the cradle.

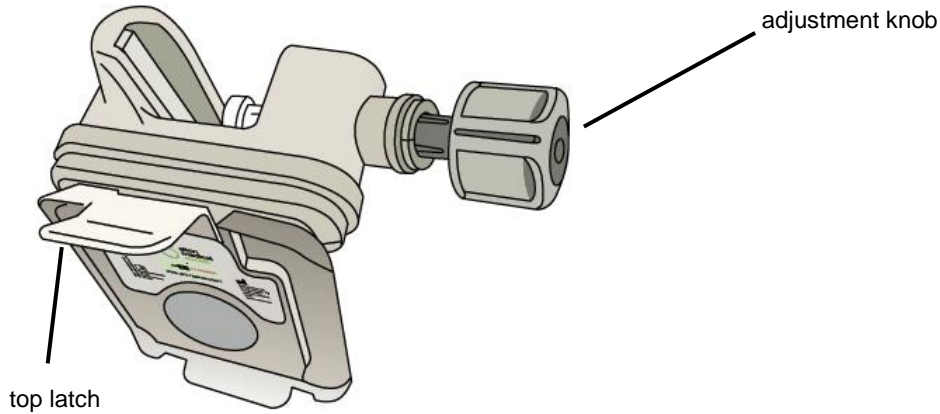

1. Visually inspect the cradle for cracks.



### Warning

Do not use the cradle if it appears damaged in any way.

2. Position the cradle where desired and tighten the adjustment knob.

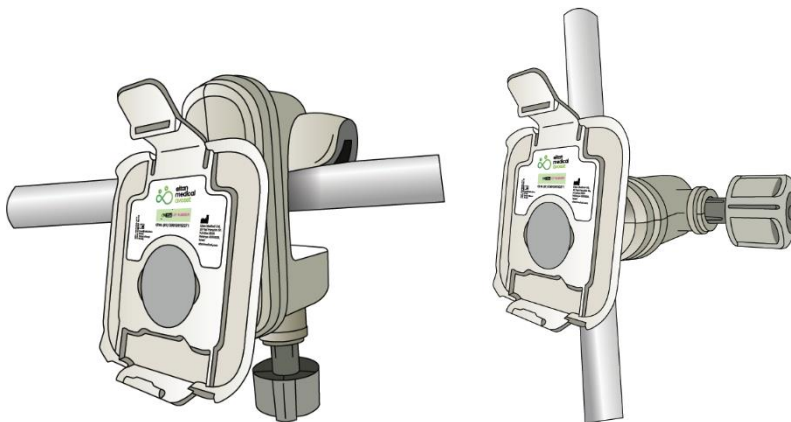

3. Align the pump with the bottom of the cradle.

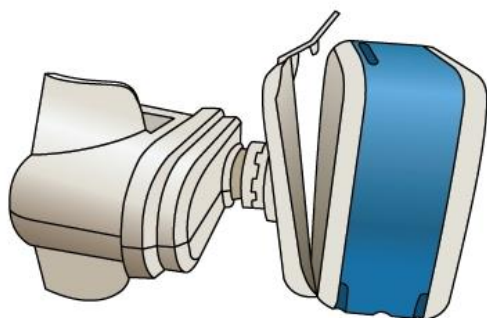

4. Press the pump back **firmly** until the top latch of the cradle clicks securely into place.

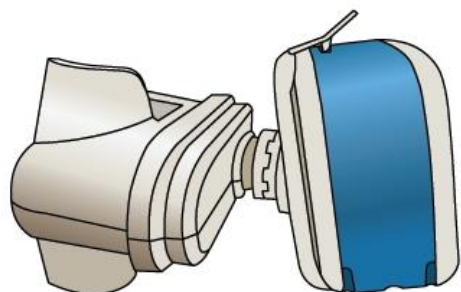

5. To release the pump from the cradle, hold the pump while pushing back firmly on the top latch of the cradle.



**Note**

Inserting the pump to the cradle (and releasing) is the same when the Cassette Lock is used.

---



**Note**

For cleaning instructions, see *Cleaning the Accessories* on p. 46.

---

# Chapter 4: Setting Up an Infusion

## Introduction

The steps needed to prepare the pump and an administration set for an infusion depend on the infusion type and the accessories needed. The workflow includes the following:

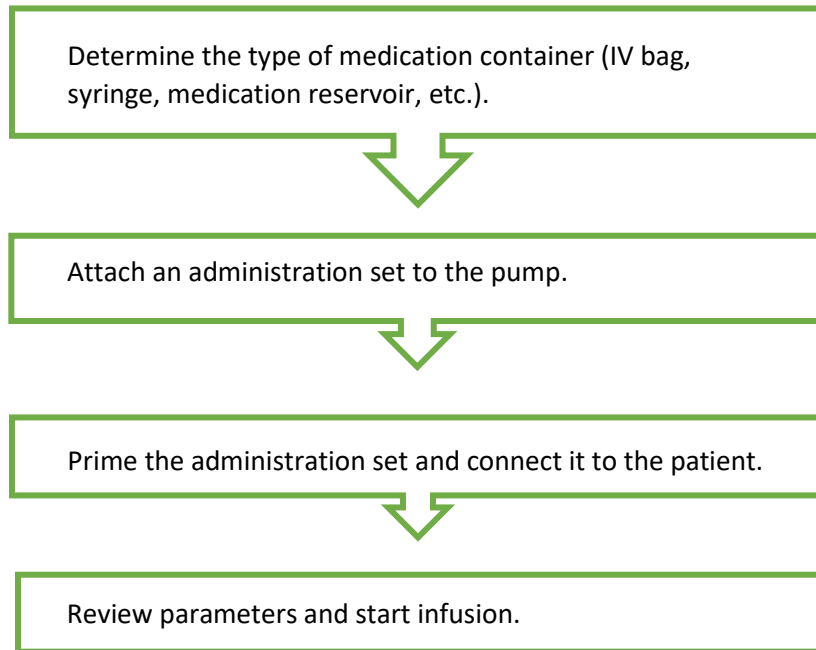

## Determining the Medication Container

The pump can be used with either an infusion bag, a dedicated medication reservoir, or a syringe.

### IV Bag

When using an IV bag:

1. Clamp the administration set line.
2. Remove the cap from the administration set's spike.
3. Spike the bag.
4. Hang the bag from an IV pole.

## Syringe

When using a syringe:

---



### Note

The pump is compatible with syringes 5 mL or larger.

---

1. Attach a syringe holder (for example, to an IV pole) according to the manufacturer's instructions.
  2. Verify the syringe is filled.
  3. Clamp the administration set line.
  4. Connect the administration set to the syringe with a luer connector. Twist to connect.
  5. Mount the syringe on its holder. Refer to the manufacturer's instructions for the syringe holder.
- 



### Caution

Do not push or pull the syringe plunger after the administration set is attached to the pump.

---

## Medication Reservoir (pre-filled cartridge)

When using a medication reservoir:

1. Verify that the medication reservoir is filled and the administration set line is clamped.
2. Attach an extension line using a luer connector to the medication reservoir tube.

## Priming the Administration Set

Attach the administration set (see *Attaching the Administration Set* on p. 18).

Before beginning an infusion, the administration set needs to be primed. Priming expels all the air from the administration set, and fills it with the infusion liquid.

There are two priming methods:

- Automatic: use the pump to prime an administration set that's attached to it. If possible, **always use automatic priming**.
- Manual: prime an administration set without the pump.



### Warning

- Do not prime with the administration set connected to the patient.
  - Do not start without verifying that all clamps are opened and that there is no occlusion.
  - Do not allow air into the administration set during priming.
  - Do not use the administration set before verifying that all air bubbles have been expelled.
- 

## Automatic Priming

Automatic priming is available when the pump is turned ON, with an administration set attached to it, either before infusion, or while infusion is paused.

Priming volume is not subtracted from the VTBI or added to the VI. Therefore, calculate the infusion bag's volume to include patient infusion **plus** priming volumes.



### Note

Priming may require a password (see *Password Protection* on p. 31).

---

1. Make sure that fresh batteries have been installed in the pump, pump is ON, and an administration set is attached to the pump.
2. Make sure the administration set is **disconnected** from the patient.
3. Press **PRIME**.  
The screen displays `DISCONNECT PATIENT` as a reminder.
4. Open all administration set clamps.
5. Press **□** [PRIME].  
The pump begins to pump fluids from the bag through the administration set. The screen displays `PRIMING`.
6. Press **STOP** or **START/PAUSE** when the administration set is primed or wait for the automatic process to finish (when the screen displays `PRIME COMPLETE`).

7. Press  [OK].

The screen displays VERIFY AIR IS OUT OF LINE.

8. If there is no air, press  [NO AIR].

The screen displays CONNECT SET TO PATIENT.



**Note**

If you are using the Cassette Lock, attach it now (see *Attaching the Cassette Lock* on p. 20).

If you are using the cradle, attach it now (see *The Cradle* on p. 21).

---

9. Connect the administration set to the patient's access line with a luer connector. Twist to connect. Once the patient is connected, press  [OK].
10. Proceed to *Reviewing Parameters* on p. 27.

## Manual Priming

Manual priming is performed without the pump.

1. Disconnect the administration set from the patient.
2. Disconnect the administration set from the pump (see *Removing an Administration Set from the Pump* on p. 19).
3. Open all administration set clamps.
4. Press and hold the cassette's AFFV valve.  
Infusion fluid flows through the administration set and primes it.
5. Release the AFFV valve when the administration set is primed.
6. Attach the administration set to the pump (see *Attaching the Administration Set* on p. 18).
7. Connect the administration set to the patient's access line with a luer connector. Twist to connect.
8. Proceed to *Reviewing Parameters* on p. 27.



# Reviewing Parameters

Before starting the infusion, you must review the parameters:

- If the pump is being used for the first time (for this patient), or if parameters were changed in the previous treatment, there is a mandatory review of all the infusion program parameters.
- If this is not the first-time usage and no parameters have changed, review is optional. You can review all parameters before starting the infusion.

To review:

1. Press .
2. Use  and  to browse the parameters.
3. For a detailed explanation of all parameters, see *Chapter 6: Program Types* on p. 33.
4. After reviewing, proceed to *Starting an Infusion* on p. 28.

# Chapter 5: Basic Functions

## Starting an Infusion

### Starting

1. Make sure the patient is positioned comfortably:

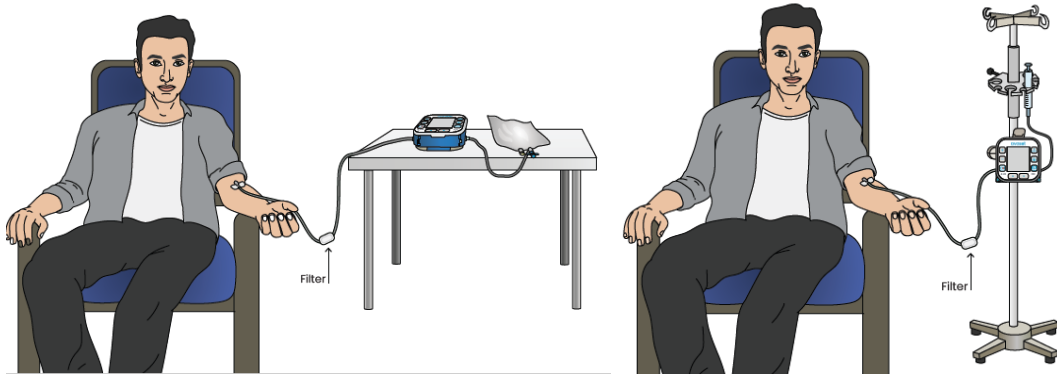

IV BAG

SYRINGE WITH STAND



#### Note

When using an administration set with a filter, place the filter **below** (lower than) the patient's IV line access point.

2. Turn on the pump. When you turn on the pump, what you see on the screen depends on the situation:
  - **New Infusion:** If this is a new infusion, you must review parameters (see *Reviewing Parameters* on p. 27). Then continue with step 3.
  - **Previous Infusion Completed:** If the previous infusion completed, you see the main screen for the infusion. Continue with step 3.
  - **Turned Off Before Completion:** If the pump was turned off before the previous infusion completed, the pump screen displays `START NEW BAG OR RESUME?` If you are starting a new infusion, press  [`START NEW BAG`].
3. Press **START/PAUSE**.  
The infusion begins.



### Warning

Before starting an infusion, always verify that the medication reservoir contains the correct drug.

---



### Caution

To avoid affecting pump accuracy, do not place the pump more than one meter below or above the patient. See *Pump Accuracy* on p. 58.

---

## Pausing

To pause the pump during an infusion, press **START/PAUSE**.

## Delaying the Start

The pump can be programmed for a delayed start from the Avoset Programming Tool.

If the patient turns the pump ON and presses **START/PAUSE** before the pump was scheduled to be started, the pump starts delivering the fluid in a KVO rate until the scheduled time is due. The time remaining before infusion starts is displayed on the screen (HH : MM). When infusion begins, the pump changes the infusion rate accordingly.

The Delay Start only applies for that single defined date and time; it will not affect future infusions.



### Note

The VTBI would not be decreased or affected in any way when a KVO is programed with a delayed start.

---

## Ending an Infusion

When the programmed VTBI has been delivered and infusion concludes, the screen displays **INFUSION COMPLETE**.



### Note

For Intermittent program time, the screen displays **TIME TO CHANGE BAG** instead of **INFUSION COMPLETE** (see *Changing the Bag* on p. 40).

---

## Without KVO

To end an infusion **without** KVO (KVO is set to zero):

1. Press  [DISMISS] to dismiss the **INFUSION COMPLETE** alarm.
2. The screen displays **CHANGE BAG OR TURN OFF**.

## With KVO

To end an infusion **with** KVO (KVO is set to a value other than zero):

1. Press  [DISMISS] to dismiss the INFUSION COMPLETE alarm.  
The pump continues to deliver liquid at the KVO rate and the screen displays INFUSION DONE KVO RUNNING.
2. Press **START/PAUSE** to pause the KVO.  
The screen displays INFUSION DONE KVO PAUSED .
3. Press  [NEW BAG].  
The screen displays QUIT KVO NOW?
4. Press  [YES].

## Turning Off (shutting down) the Pump

To turn off the pump:

1. Make sure the pump is idle. If a program is running, press **START/PAUSE** to pause the infusion.
2. Press and hold down **ON/OFF** for 3 seconds.



### Note

The pump turns off and the settings are saved.

---

## Password Protection

Specific pump features may be protected by a password to prevent unauthorized modification. Features shown in this table with \* can have their password protection turned on/off from the Avoset Programming Tool.

Mode	Password-protected Features
Continuous	Edit * Automatic prime *
Intermittent	Next dosage start time Automatic prime *
Taper	Edit * Immediate taper down * Automatic prime *
PCA	Edit Clinician dose Automatic prime Clear PCA bolus history *

When attempting to use a locked feature, a password screen appears. The password consists of 3 digits.

To unlock a feature:

1. Use the **+** and **-** buttons to enter the password's first digit.
2. Press **□** [NEXT].  
The second digit flashes.
3. Repeat steps 1 and 2 to set the password's 2<sup>nd</sup> and 3<sup>rd</sup> digits.  
Press **□** [CLEAR] to reset the entered digit.
4. Press **□** [OK].  
The feature is unlocked.

## Pairing with the AvosetGo Mobile App

Data from the current infusion program on the pump can be made available in the Insights Tool during infusion. This is done via AvosetGo app.

The Insights Tool is a cloud-based platform that includes modules for pump fleet management and treatment monitoring (not covered in this user manual).

The AvosetGo app passes the pump's event log to the Insights Tool. The data transfer is only from the pump to the mobile app and does not affect the pump performance.

To pair the pump with the AvosetGo app:

1. Download the AvosetGo app to your device and follow the pairing instructions in the app.
2. On the pump, press **START/PAUSE** to pause the pump.
3. Hold down the **–** button for 2 seconds.  
The screen displays `START NEW PAIRING?`
4. Press **□** [OK].  
A 6-digit code appears on the pump screen. It remains for 60 seconds.
5. Enter the code in the AvosetGo app.



### Note

The pump can be paired only from the main screen and when paused (not running).

---

# Chapter 6: Program Types

## Introduction

The Avoset Infusion Pump can be operated in four different program types:

- Continuous: the basic infusion operation, in which the pump delivers the infusion at a fixed rate.
- Intermittent: multiple doses delivered at regular intervals and defined rates. Between doses, a KVO rate is available.
- Taper: a plateau rate of infusion is maintained, with the option of tapering values up at the beginning and/or tapering them down at the end. Taper mode has an optional programmable KVO rate at the end of the infusion
- Patient Controlled Analgesia (PCA): boluses patients can self-administer within defined limits.

The program type is selected using the Avoset Programming Tool.



### Note

The pump can be manually programmed in Continuous programs only. See *Manual Programming (on-pump titration)* on p. 44.

---

## Identifying the Current Program Type

If you receive a pump and are not sure how it was programmed, there are unique features in each program type that allow you identify the currently-programmed infusion type:

1. Turn the pump on and press  [REVIEW].
2. Search for one of these parameters in the Review screen by pressing  [NEXT]:
  - TAPER UP DURATION = Taper infusion type
  - BOLUS VOLUME = PCA infusion type
  - DOSE DURATION = Intermittent infusion type
  - If none of the above exist, the program type used is Continuous, which includes only RATE and VTBI.

# Viewing and Editing Parameters

Review and edit program parameters as follows. The parameters you see depend on the infusion type.

## To view:

During infusion, press **□** [INFO] to view the current values of the parameters. Press and hold **□** [NEXT] for 3 seconds to return to the main screen.

## To edit:



### Note

- Not all parameters may be edited.
  - Some parameters may be password-protected.
  - Any changes to infusion parameters are saved and will be in effect for the next treatments.
- 

1. If the pump is running, press **START/PAUSE** to pause the pump.  
If the pump is not running or the infusion has not yet been started, editing is immediately available.
2. Press **□** [EDIT] on the main screen.
3. Follow the on-screen prompts.
  - To change a parameter value using the **+** and **-** buttons, then press **□** [OK] to confirm.
  - To skip to the next parameter, press **□** [SKIP].
4. When you have reviewed all parameters, you are prompted to confirm any edits:
  - Press **□** [OK] to confirm or **□** [EDIT] to made changes.
  - To discard changes, press **□** [BACK] and then **□** [OK].
  - When you have confirmed all edits, the main screen appears.
5. Press **START/PAUSE** to resume infusion.



## Parameter Values



### Note

Parameters marked as optional may or may not appear on the pump, depending on the infusion program that was downloaded from the Avoset Programming Tool.

## Continuous

Parameter	Description
(Parameters marked with * may be edited.)	
<b>Parameters to review before infusion begins:</b>	
Concentration (optional)	Drug concentration
Rate *	Amount of fluid delivered per hour
VTBI *	Total volume to be infused during infusion
Duration	Infusion duration
KVO * (optional)	Keep Vein Open rate
Starts in (optional)	Infusion delay duration (amount of time before starting)
<b>Parameters that can be viewed during infusion.</b>	
Duration remaining	The amount of time left before the infusion ends
Volume infused	Total volume infused during this infusion <i>so far</i>
VTBI	Total volume to be infused during infusion
KVO	Keep Vein Open rate
Concentration * (optional)	Drug concentration
<b>Editability of parameters in Continuous mode:</b>	
Before infusion begins:	Rate, VTBI
During infusion:	Rate

## Intermittent

Parameter	Description
(Parameters marked with * may be edited.)	
<b>Parameters to review before infusion begins:</b>	
Concentration (optional)	Drug concentration
Dose Rate	Amount of fluid delivered per hour
KVO	Keep Vein Open administration rate
VTBI	Total liquid volume to be infused during infusion, including all doses and all the between doses volume that is delivered in KVO rate
Dose Volume	Volume of each intermittent dose
Dose Interval	Time between a beginning of one dose and the beginning of the following dose
Number of Doses	Total infusion doses
Dose Duration	Intermittent dose delivery duration
Total Duration	Amount of time for the entire infusion, from the start of the first dose till the end of the last KVO
Dose Reminder (optional)	(When infusion was paused during KVO) next dose notification
Starts in (optional)	Infusion delay duration
<b>Parameters that can be viewed during infusion, during dose.</b>	
Dose Duration Remaining	The amount of time left before the current dose ends
Total Duration Remaining	The amount of time left before infusion ends
Volume Infused	Total amount of liquid infused during this infusion
VTBI	Liquid volume yet to be infused during this infusion
Dose Volume	Volume of each intermittent dose
Concentration (optional)	Drug concentration
KVO	The rate used between doses to keep the vein open
Dose Interval	Time between a beginning of one dose and the beginning of the following dose
Dose Duration Remaining	The amount of time left before the current dose ends
<b>Parameters that can be viewed during infusion, between doses (in addition to the parameters above).</b>	
Completed Dose X of Y	Number of doses infused (X) and total number of doses (Y) in the current infusion.
Next Dose in *	The amount of time left before the next dose begins (May be edited only when infusion is between doses.)
<b>Editability of parameters in Intermittent mode:</b>	
Before infusion begins:	none
During infusion:	Next Dose in

## Taper

Parameter	Description
(Parameters marked with * may be edited.)	
<b>Taper parameters to review before infusion begins:</b>	
Plateau Rate	Rate of infusion between tapering phases
Taper Up Duration *	Amount of time rate increases until reaching the plateau rate
Taper Down Duration *	Amount of time rate decreases from the end of the plateau rate
VTBI *	Total liquid volume to be infused
Total Duration *	Amount of time for the entire infusion
KVO * (optional)	Keep Vein Open administration rate
Starts in (optional)	Infusion delay duration
<b>Taper parameters that can be viewed during infusion.</b>	
Total Duration Remaining	The amount of time left before infusion ends
Volume Infused	Total amount of liquid pumped during this infusion
VTBI	Total liquid volume to be infused
Plateau Rate	Rate of infusion between tapering phases
Taper Up Duration	Amount of time rate increases until reaching the plateau
Taper Down Duration	Amount of time rate decreases from the end of the plateau
<b>Editability of parameters in Taper mode:</b>	
Before infusion begins:	all
During infusion:	none

## PCA

Parameter	Description
(Parameters marked with * may be edited.)	
<b>Parameters to review before infusion begins:</b>	
Concentration (optional)	Drug concentration
Loading Dose Volume (optional)	A loading dose is an optional clinician bolus given at the beginning of the infusion. Loading dose is available only when the first infusion is delivered. When repeating the same infusion, Loading Dose is unavailable.
Loading Dose Duration (optional)	
Continuous Rate *	Infusion rate between bolus doses
VTBI	Drug volume to be infused during this infusion
Lockout Duration *	Amount of time between boluses when the user cannot initiate a bolus
Bolus Volume *	Volume pumped during a bolus
Max boluses per one hour / Dose limit per xx hours (optional)	Lockout duration limit type
KVO (optional)	Keep Vein Open administration rate
Starts in (optional)	Infusion delay duration
<b>Parameters that can be viewed during infusion:</b>	
Lockout Duration	Time until the next bolus is available. When bolus is available, this parameter is not.
Volume Infused	Total amount of liquid infused during this infusion
VTBI	Drug volume yet to be infused during this infusion
Last Clear of Bolus History	Time elapsed since bolus history was last cleared
Bolus Req. X Bolus Giv. Y	Number of boluses requested (X) and number of boluses initiated (Y)
Bolus Volume	Volume pumped during a bolus
Max boluses per one hour / Dose limit per xx hours	Lockout duration limit type
Concentration (optional)	Drug concentration
Lockout Duration *	Time until the next bolus is available. When bolus is available, this parameter is not.
Volume Infused	Total amount of liquid infused during this infusion
<b>Editability of parameters in PCA mode:</b>	
Before infusion begins:	Rate, Bolus Volume, Lockout Duration
During infusion:	Rate, Bolus Volume, Lockout Duration

# Additional Program Information

## Intermittent

### Interrupting Infusion in Intermittent Mode

When you pause the pump in Intermittent mode, the way an infusion resumes depends on the stage at which it was paused and on the duration of the pause. Here are the most common interruption scenarios and how an infusion would resume.

Scenario	How Infusion Resumes
Infusion is paused during a dose and then resumed before the next dose is scheduled.	The paused dose continues. The next dose is scheduled with a delay of the same duration as the pump's pause.
Infusion is paused during a dose and resumed after the time has come to begin the next dose.	The interrupted dose is skipped. All other doses are postponed by a duration equal to the pause after the scheduled dose was supposed to begin.
Infusion is paused during KVO and resumed <b>before</b> the next dose is scheduled.	Pump returns to KVO rate and the next dose starts as scheduled.
Infusion is paused during KVO and resumed <b>after</b> the next dose is scheduled.	Pump immediately begins infusing the next dose. All doses are postponed by a duration equal to the pause after the scheduled dose was supposed to begin.
A new bag is inserted before the last KVO interval elapses. The user pauses the pump, replaces the set, and presses <input type="checkbox"/> [YES] to the prompt WAS THE BAG CHANGED?	Pump returns to KVO rate. Dose #1 will be delivered at the end of the current interval.
Bag replacement during a dose. The user pauses the pump, replaces the set, and presses <input type="checkbox"/> [YES] to the prompt WAS THE BAG CHANGED?	The pump skips the remaining volume, returns to KVO and delivers Dose #1 when the next interval is scheduled.

### Editing “Next dose in”

In Intermittent mode, when the pump is between doses, you can shorten the time between doses to initiate the next dose sooner.



#### Note

- This feature can be protected by a password (see *Password Protection* on p. 31).
- Only the current interval is cut short by this feature; subsequent interval lengths remain the same.
- As a result of using this feature, the schedule of subsequent doses changes. The rest of the intervals remain unchanged.

1. Press **START/PAUSE**.
2. Press  [INFO].  
The infusion parameters appears.

3. Press **NEXT** to browse the parameters until `NEXT DOSE IN` is displayed on the screen.
4. Press  [EDIT].  
The `ENTER PASSWORD` screen appears.
5. Enter the password and press  [OK].
6. Modify the parameter using the **+** and **-** buttons, and then press  [OK] to confirm.  
The `NEXT DOSE IN` screen appears, showing the updated value.
7. To discard changes, press  [BACK].  
The interval cannot be adjusted to be longer than its pre-set value.
8. Press **START/PAUSE** to resume infusion.

## Using the Dose Reminder

When the optional Dose Reminder feature is active, and the pump is paused between doses (during KVO), the `PUMP IS PAUSED` alarm is disabled, and a notification prompts the user to manually resume infusion in a predefined amount of time before the next dose is scheduled. The Dose Reminder parameter defines how much time before the next Dose Reminder prompts the user.



### Note

- The `PUMP IS PAUSED` alarm is disabled when Dose Reminder is enabled.
  - Dose Reminder is defined or disabled using the Avoset Programming Tool.
- 

During Dose Reminder, an alarm sounds and an alternating message flashes on the screen: `PUMP IS PAUSED` and `NEXT DOSE IN XX:XX`. When the dose start time comes, `DOSE DUE NOW` appears.

## Changing the Bag

When the last dose of an infusion bag has been delivered, and the pump is in last KVO, the screen displays `TIME TO CHANGE BAG`. The time before the end of the last interval when this prompt appears can be configured via the Avoset Programming Tool. If the bag is not changed at the appointed time, the screen displays `CHANGE BAG NOW`.

1. Replace the depleted infusion bag and set with new ones.  
The message `START NEW BAG OR RESUME?` appears if attaching a new administration set or turning the pump back ON.
2. Press  [NEW BAG].  
The screen displays `START NEW INFUSION?`
3. Press  [YES].  
A new cycle of doses begins.

## Taper

### Using Immediate Taper Down

This feature, when made available via the Avoset Programming Tool, allows the user to end the infusion with a gradual decrease in infusion. Immediate Taper Down becomes available after the infusion reaches its plateau, and **TAPER D** appears on the main screen.



#### Note

Editing Taper Down parameters may be password protected.

---

1. Press **□** [**TAPER D**].  
The screen displays **START TAPER DOWN NOW?**
2. Press **□** [**YES**].  
The pump ends the infusion gradually.

## Patient Controlled Analgesia (PCA) Mode

### Bolus Button

PCA mode allows the patient to relieve pain during infusion by releasing high dose (Bolus) medications on demand. Bolus can be infused once in a set amount of time. The duration in which a single bolus is allowed can be reviewed before and during infusion.

- Bolus is available from the **BOLUS** button.
- After pressing **BOLUS**, the pump displays a flashing message **BOLUS DELIVERING**. Until the bolus ends, either automatically when it's done or manually by the user, other screens are unavailable.
- During a bolus, press **START/PAUSE** to pause the pump. When resuming pump operation (by pressing **START/PAUSE** again) the pump returns to the basic, and not the bolus, rate.
- A new bolus becomes available again after the lockout time ends.

### Bolus Lockout

After delivering a bolus, a lockout period between boluses prevents the user from requesting any additional boluses until the lockout period elapses. If the user presses **BOLUS** during the lockout period, the pump indicates that it is locked out for x amount of time.

## Clearing Bolus History

Avoset records and aggregates the number of times bolus was requested and the number of times it was administered.



### Note

Clearing Bolus History parameters may be password protected.

To clear this history:

1. Press  [INFO] during PCA infusion.
2. Press  [INFO] again.  
The infusion parameters appears.
3. Press  [NEXT] to browse the parameters until the screen displays BOLUS REQ . X BOLUS GIV . Y.



### Note

This feature is also available when viewing the Total Bolus Infused parameter.

4. Press  [CLEAR].  
Bolus history is cleared.

## Using Clinician Dose

Clinician dose is an optional way for the clinician to add bolus to the patient **during** a PCA infusion. (This feature is only available when the pump is running.) To deliver Clinician dose:

1. Press  [CLINIC . D] during PCA infusion.
2. Enter the password, then press  [OK].
3. Set bolus volume using the + and - buttons, and then press  [OK] to confirm.  
The screen displays GIVE CLINICIAN DOSE?
4. Press  [YES].  
The screen displays DELIVERING C . DOSE.

To quit Clinician Dose:

1. Press **START/PAUSE** during Clinician bolus.  
Pump operation is paused and the screen displays C . DOSE PAUSED.
2. Press  [QUIT].



The screen displays QUIT CLINICIAN DOSE?

3. Press  [YES].

The screen displays RESUME CONT. RATE?

4. Press  [YES] to revert to Continuous rate or  [NO] to cancel.

## Setting the Loading Dose

Loading dose is available only for the first infusion. Consequent infusions start with the Continuous rate.

If a Loading dose is set in the program:

1. Press **START/PAUSE**.

Loading dose delivery begins. The screen displays LOADING DOSE DELIVERING . . . .

2. When Loading dose concludes, the pump proceeds to Continuous rate.

To quit Loading Dose:

1. Press **START/PAUSE** to pause the pump.

When pausing the pump during Loading dose delivery, the screen displays LOADING DOSE PAUSE.

2. Press  [QUIT].

The screen displays QUIT LOADING DOSE?

3. Press  [YES] to abort the Loading dose and proceed to paused Continuous rate.

4. Press  [NO] to return to paused Loading dose.

## Viewing and Editing Parameters when the Pump Is Paused

When running in PCA mode, you can pause the infusion to view or edit parameters:

1. Press **START/PAUSE** to pause the pump.

The left multifunction key changes from C DOSE to EDIT.

2. Press  [EDIT].

You can now view all the parameters and change those parameters that are available for editing.

## Continuous

### Manual Programming (on-pump titration)

Manual programming and operation of the pump is possible in Continuous mode, when the pump has no infusion program installed.

To program the pump manually:

1. Turn the pump ON.  
The `SET RATE` screen appears.
2. Set the infusion rate using the `+` and `-` buttons, then press `□` [OK].  
The `SET VTBI` screen appears.
3. Set the VTBI using the `+` and `-` buttons, then press `□` [OK].  
A confirmation screen appears, showing the RATE and VTBI values you entered.
4. Press `□` [CONFIRM].  
The main screen appears, with `PRESS START` flashing.

# Chapter 7: Maintenance

## Cleaning and Disinfecting

Between use on different patients, the pump and all of its components need to be first cleaned thoroughly and then disinfected thoroughly, per hospital/medical provider protocol for multiple patient use.

Acceptable cleaning agents are:

- **pump:** 70% IPA (isopropyl alcohol)
- **accessories:** 70% IPA (isopropyl alcohol)
- see the website ([eitanmedical.com](http://eitanmedical.com)), as this list may be updated with additional cleaning agents



### Warning

**Do not** clean or disinfect *unless*:

- The pump is disconnected from the patient.
- The pump is disconnected from all sets and accessories.
- The pump is turned OFF.



### Caution

Do not clean or disinfect the pump unless you are trained.



### Caution

**While** cleaning or disinfecting:

- Do not clean, disinfect, or sterilize any part of the pump by autoclaving, or with ethylene oxide gas. Doing so may damage the pump and void the warranty. Disinfect only the external parts of the pump.
  - Do not allow fluid (including cleaning agents) to enter the pump (including speaker holes, cassette socket, or battery compartment).
  - Do not steam autoclave, ethylene oxide sterilize, or immerse any part of the pump in fluid.
  - Do not use spray or aerosol cleaners.
  - Dispose of all cleaning/disinfectant materials per regulations for infectious waste disposal.
-

## Cleaning the Pump

1. Turn the pump OFF and disconnect it from the patient.
2. Remove the administration set and batteries.
3. Close the battery compartment.
4. Apply the 70% isopropyl alcohol to a cloth, then wring the cloth out to remove excess liquid.
5. Wipe all exterior areas in back-and-forth motions, vertically and horizontally. Perform 3 cycles of the exterior wipe-down, verifying complete coverage of the areas to be cleaned.



### Note

Verify that the cloth does not dry out during the cleaning process. If required, wet the wipe again in the same manner.

---

6. Wipe the pump's cassette slot in vertical or horizontal movements, where possible. Wipe less-accessible areas in bi-directional rotations. Perform 6 cycles of the cassette slot wipe-down, verifying complete coverage of the areas to be cleaned.
7. Let the pump dry for 5 minutes.
8. Wipe the pump with a clean dry cloth. Inspect the cloth for any residue.



### Caution

Do not use any cleaning agents when cleaning the battery contacts.

---

## Disinfecting the Pump

1. After cleaning thoroughly, inspect the pump carefully for any residue. If there is any visible soil, repeat the cleaning steps above.
2. Repeat steps 4–8, above.

## Cleaning the Accessories

1. Remove accessories from any connections (for example, remove the cradle from the IV stand and remove the pump from the cradle).
2. Apply 70% isopropyl alcohol to a cloth. Wring the cloth out to remove excess liquid.
3. Wipe all exterior areas in back-and-forth motions, vertically and horizontally. Perform 3 cycles of the exterior wipe-down, verifying complete coverage of the areas to be cleaned.



### Note

Verify that the cloth does not dry out during the cleaning process. If required, wet the wipe again in the same manner.

---

4. Let the accessory dry for 5 minutes.
5. Wipe it with a clean dry cloth and inspect the cloth for any residue. (If necessary, repeat cleaning until there is no visible residue on the cloth.)

## Disinfecting the Accessories

1. After cleaning thoroughly, inspect the accessories carefully for any residue. If there is any visible soil, repeat the cleaning steps above.
2. Repeat steps 2–5, above.

## Maintenance (Visual Inspection)

Before providing a patient with a pump, always perform a visual inspection.

1. Examine the pump. Look for cracks in the casing, screen, battery compartment, and external parts of the pumping area (particularly the cassette socket).
2. Press the **ON/OFF** button to turn the pump ON.

As the pump performs an automatic system check, verify that:

- The LCD screen lights up.
- All areas of the screen are visible, with no stripes or dead pixels (black or white areas covering part of the screen).
- The pumps beeps.
- The green LED Run indicator turns on.
- The LED Alarm indicator turns on (first yellow and then red).
- The pump's serial number and software version appear briefly.

During automatic system check, the pump performs a built-in self-test and continually monitors its own state to detect malfunction of the following elements during operation: encoder, index, and motor for motion control, speaker, backup buzzer, microcontroller, force sensor, and free flow protection mechanism. If the automatic system check does not pass, an appropriate alarm will be triggered.



### Caution

If there are any visible cracks or if any of the automatic system check events do not occur as described above, do not use the pump. Contact your service provider or Eitan Medical.

---

Apart from this visual inspection and automatic system check at the beginning of any start up, there is no mandatory maintenance for the pump as there is no accuracy degradation or impairment in air and occlusion detection.

# Optional Testing

If you wish to perform a functional test of the pump, follow these protocols.

## Required Equipment

The entire testing process must be performed with the following equipment:

- 100 mL infusion bag (or larger) with water
- 25 mL calibrated graduated cylinder (minimal accuracy  $\pm 0.25\text{mL}$ ) Class A
- waste bin
- ambient environmental temperature for testing:  $20\pm 5\text{ }^\circ\text{C}$  ( $68\pm 10\text{ }^\circ\text{F}$ )
- Avoset administration set without a filter
- AvosetPad
- PC with the Avoset Programming Tool installed (see the Avoset Programming Tool User Manual)
- Avoset Infusion Pump with these settings:

Infusion Settings	
Type	Continuous.
Drug	(any drug type)
Units	mL
Rate	125 mL/hour
Volume	20 mL

Pump Settings	
Prime Reminder	OFF
Automatic Prime	unlocked
Edit Infusion	unlocked
Air in Line	0.5 mL
Occlusion Sensitivity	high
Occlusion Auto Restart	OFF
KVO Rate	0 mL

## Delivery Accuracy Test

Start with the delivery accuracy test as follows:

1. Install 3 fresh batteries.
2. Turn the pump ON and verify that everything is working (see *First Time Usage/Visual Inspection* on p. 14).
3. Attach a new Avoset administration set to the infusion bag.
4. Attach the Avoset administration set to the pump (see *Attaching the Administration Set* on p. 18). Pull the cassette gently to verify it is attached properly.
5. Dispose of the administration set's male luer cap in the waste bin.
6. Press **PRIME** and verify that the pump is priming and that there are no air bubbles in the administration set when priming is complete.
7. Place the infusion bag at the same level as the pump. Place the 25 mL graduated cylinder on a levelled surface and adjust the pump to its height, so that the bottom of the pump is level with the top of the cylinder. You may use a stand to level the equipment.
8. Place the administration set's male luer into the cylinder.
9. Press **START/PAUSE** and verify that the treatment is running.
10. Verify that **INFUSION COMPLETE** is displayed on the screen when infusion concludes.
11. Remove the administration set from the cylinder.
12. Turn the pump OFF.
13. Read the pumped water level on the graduated cylinder:
  - If the volume is between 19 and 21 mL, the pump successfully passed the delivery accuracy test, and you can continue with the occlusion detection test, below.
  - If the volume is not between 19 and 21 mL, repeat the test with a new set. If test fails the second time, contact your service provider or Eitan Medical.

## Occlusion Detection Test



### Note

If continuing from the delivery accuracy test, start on step 3, below.

1. Install 3 fresh batteries.
2. Turn the pump ON and verify that everything is working (see *First Time Usage/Visual Inspection* on p. 14).

3. Attach a new Avoset administration set to the infusion bag and prime. Close the administration set's downstream slide clamp all the way.
4. Attach the Avoset administration set to the pump (see *Attaching the Administration Set* on p. 18). Pull the cassette gently to verify it is attached properly.
5. Dispose of the administration set's male luer cap in the waste bin.
6. Turn the pump ON.
  - If the pump screen displays `START NEW BAG OR RESUME?`, press  [NEW BAG].
  - If the message does not appear, continue to next step.
7. Press **START/PAUSE** and verify that, after no more than 20 seconds, the screen displays `DOWNSTREAM OCCLUSION`.
8. Dismiss the alarm.
9. Open the administration set's downstream slide clamp all the way to relieve the induced pressure.
10. Press **START/PAUSE** and verify that the treatment resumed and the Downstream Occlusion alarm does not recur in the next 2 minutes of infusion.
  - If the alarm does not recur, the pump successfully passed the occlusion detection test, and you can continue with the air detection test, below.
  - If the alarm recurs, repeat the test with a new set. If test fails the second time, contact your service provider or Eitan Medical.
11. Press **START/PAUSE**.
12. Turn the pump OFF.

## Air Detection Test

---



### Note

If continuing from the delivery occlusion detection test, start on step 3, below.

---

1. Install 3 fresh batteries.
2. Turn the pump ON and verify that everything is working (see *First Time Usage/Visual Inspection* on p. 14).
3. Attach a new primed Avoset administration set to the infusion bag.
4. Attach the Avoset administration set to the pump (see *Attaching the Administration Set* on p. 18). Pull the cassette gently to verify it is attached properly.
5. Dispose of the administration set's male luer cap in the waste bin.
6. Turn the pump ON.



- If the pump screen displays `START NEW BAG OR RESUME?`, press  [NEW BAG].
  - If the message does not appear, continue to next step.
7. Press **START/PAUSE**.
  8. Inject air into the tubing by inverting the infusion bag to allow air into the administration set, or removing the spike to let air in.
  9. Verify that the screen displays `AIR IN LINE PRIME SET`.
  10. Turn the infusion bag right side up again (or respoke the bag) to allow fluid to fill the administration set.
  11. Prime the administration set (see *Priming the Administration Set* on p. 25).
  12. Press **START/PAUSE** and verify that the treatment resumed and the Air in Line alarm does not recur in the next 2 minutes of infusion.
    - If the alarm does not recur, the pump successfully passed the air detection test.
    - If the alarm recurs, repeat the test with a new set. If test fails the second time, contact your service provider or Eitan Medical.
  13. Press **START/PAUSE** button. Turn the pump OFF.

## Transportation and Storage

The following transport and storage guidelines apply to new pumps and pumps that are stored between patients, as well as accessories (include the cradle and the Cassette Lock):

- Store the pump in a clean and dry environment to prevent it from getting dusty or dirty.
- Before storing the pump, disconnect the administration set and remove the batteries.
- The pump can be carried in any orientation within a backpack, a pouch, or by any other means that keeps it enclosed, without risk of parts detaching.

Condition	Minimum	Maximum
Storage Temperature (up to 72 hours)	-40° C (-40° F)	70° C (158° F)
Storage Temperature (if over 72 hours)	5° C (41° F)	40° C (104° F)
Humidity	15 %RH	95 %RH
Atmospheric Pressure	50 kPa	106 kPa



After storing the pump in an environment that does not comply with the pump's operating conditions, before operating it again, place it in a suitable operation environment for at least two hours.

# Chapter 8: Alarms (Troubleshooting)

During its operation, the Avoset Infusion Pump identifies functional issues and problems as they arise, and notifies the user by:

- On-screen icon 
- Flashing indicator: color denotes alarm priority
- Alarm audio: audio volume denotes alarm priority
- Alarm text (explaining the problem and/or providing instructions to resolve it) appears on the pump screen

## To silence an alarm:

To temporarily silence the alarm audio, press  [MUTE]. The on-screen icon changes to . If the alarm condition persists, the alarm audio resumes after 2 minutes.

## To dismiss an alarm:

To dismiss the alarm after the alarm condition has been resolved, press  [DISMISS]. If the alarm condition was not resolved, the alarm will occur again.

## Alarm Priority

Pump alarms are grouped here by their priority:

Priority	Sound Volume (in dBA) at 1 meter		Behavior of Pump	Resolution
	High (default)	Low		
High Priority Error	70 ± 2	62 ± 2	Red indicator flashes. Infusion is stopped.	Immediate response is required. Cannot be resolved in the field. Requires replacement of pump.
High Priority Alarm	70 ± 2	62 ± 2	Red indicator flashes. Infusion is paused until the problem is resolved.	Immediate response is required. Can be resolved with immediate action.
Low Priority Alarm	62 ± 2	54 ± 2	Yellow indicator flashes. Infusion continues.	User awareness is required. User attention is required.



### Note

- When infusion stops following an alarm, residual volume will be administrated. It will not exceed 0.15 mL (when using *Microbore* tubing) or 0.30 mL (when using *Macrobore* tubing).
- Auditory information signals are 50 ±2 dBA.
- The pump may experience multiple alarm triggers at the same time. High priority alarms are always displayed before low priority alarms.



### Caution

- Pay attention in noisy settings. Alarm audio levels that are less than ambient levels can impede operator recognition of alarm conditions.
- Pay attention in environments with multiple devices using alarm tones.

## Responding to Alarms

Alarms accompanied by on-screen text that explains the problem and/or how to resolve it.

Alarm Text	Cause	Resolution
<b>High-priority Errors</b>		
<i>Do not use pump.</i>		
<i>If the pump is with a patient, replace it.</i>		
ERROR 1 REPLACE PUMP	An unrecoverable error may have occurred as a result of a hardware or software fault.	Contact your service provider or Eitan Medical.
ERROR 2 REPLACE PUMP	An error occurred in the infusion program.	Perform pump programming again (see the Avoset Programming Tool User Manual).
ERROR 3 REPLACE PUMP	The pump detected an internal clock error.	Contact your service provider or Eitan Medical.
ERROR 4 REPLACE PUMP	There is a problem with the version of the software currently installed on the pump.	Update pump software (see the Avoset Programming Tool User Manual).
<b>High-priority Alarms</b>		
<i>Resolution actions to be performed in field by any trained user.</i>		
<i>Follow instructions in this table.</i>		
AIR IN LINE PRIME SET	The pump detected air in the fluid path.	Disconnect the administration set from the patient and prime the administration set (see <i>Priming the Administration Set</i> on p. 25).
CASSETTE MISPLACED	Administration set cassette missing or not installed correctly.	Reinstall the cassette.

Alarm Text	Cause	Resolution
RECOVERED FROM ERROR	The pump restarted after an internal error.	The interrupted infusion can't be resumed. VTBI was reset to the initially programmed value. If you start the infusion, it will not resume from where it stopped before interrupted.
UPSTREAM OCCLUSION	The pump detected high pressure in the tube connecting the fluid reservoir, which may be a result of an upstream blockage, empty fluid reservoir, kink in the fluid path, or a closed tubing clamp.	Straighten the tube, check for kinks, verify that the administration set is positioned correctly, and un-clamp it. To reduce the potential bolus delivery after an occlusion: 1. Resolve the occlusion.
DOWNSTREAM OCCLUSION	The pump detected high pressure in the tube connected to the patient, which may be a result of a downstream blockage, kink in the fluid path, or a closed tubing clamp.	2. Resume the infusion.
BATTERY DEPLETED	The pump stopped mid-operation: battery power is too low to operate the pump.	This error is displayed 3 minutes before the pump shuts down. Replace the batteries immediately.
Screen is off (no test is displayed)	Sudden power loss; batteries were removed or the pump suddenly lost power during operation. (Note that all pump data is saved.)	Replace the batteries and make sure that they are installed correctly.
HIGH TEMPERATURE	Pump is overheating	Turn the pump OFF and let it cool down. If the temperature is still too high when the pump is turned on, the alarm will occur again.
INFUSION COMPLETE	The VTBI has been delivered.	Dismiss the alarm, then add a new bag or turn the pump OFF.
CHANGE BAG NOW	The VTBI has been delivered.	Replace the bag.
REMOVE AND REINSERT SET	Pump was not able to take reference values related to the administration set.	Remove and reinsert the administration set.
CHECK EMPTY SET/ RESERVOIR	The bag may be empty, or there may be an air bubble $\geq 2$ mL in the fluid path.	If the bag is not empty, disconnect the administration set from patient, prime the set, then resume infusion. If the bag is empty, replace it, and resume infusion.
RESTART PUMP	The pump detected a momentary internal communication error during pump startup that prevents pump operation.	Restart the pump. If the alarm occurs for the second time, replace the pump and contact your service provider or Eitan Medical.
<b>Low-priority Alarms</b>		
ACTION INCOMPLETE	Will be prompted if no key was pressed for a predefined duration while the pump is not infusing.	Address the incomplete action.

Alarm Text	Cause	Resolution
PUMP IS PAUSED	Infusion has already started and the pump was paused or stopped for 30 seconds.	Press <b>START/PAUSE</b> if the infusion should be resumed.
TIME TO CHANGE BAG	Infusion bag is almost empty.	Replace bag.
Audio warning 1	Warning issued during treatment alerting that neither the speaker nor the buzzer are functioning properly. The alarm is <b>not</b> accompanied by audio. If the issue is not resolved, the pump will not be able to start a new treatment.	Dismiss the alarm and continue infusion while taking into consideration that there is no audio. When the pump is connected to the Programming Tool (that is, not in a clinical environment), it will be disabled for future programming.
Audio warning 2	Warning issued during treatment alerting that either the speaker or the buzzer is not functioning properly. The alarm is accompanied by audio from either part that is still working (speaker or buzzer).	The pump will operate only with buzzer or speaker. The pump sound might be different, but you will still be able to work with the pump and it will continue to provide alerts. Contact your service provider or Eitan Medical.
LOW BATTERY	Batteries are low. Note: this alarm starts 30 minutes before, and again at 10 minutes before the batteries are depleted. Then the high-priority alarm BATTERY DEPLETED occurs.	Replace batteries.
KEY STUCK	A button on the pump was pressed too long or is stuck.	Release the pressed button.
UNPRIMED SET	The pump detected air in the fluid path directly under the pumping mechanism.	Prime the set.
REPLACE SET	Set cassette failed internal pump testing.	Replace the administration set: remove connected administration set and insert a new administration set.
SW UPDATE FAILED	Pump software update failed. This alarm can only occur during programming and not in a clinical environment.	Restart pump and reload its software (see the Avoset Programming Tool User Manual).
PROGRAMMING FAILED	Infusion program was not sent to the pump. This alarm can only occur during programming and not in a clinical environment.	Resend infusion program via the Avoset Programming Tool (see the Avoset Programming Tool User Manual).

# Appendix A: Technical Specifications

## Specifications

Specification	Value						
Model Numbers	15132-000-0001 (US) 15131-000-0002 (Rest of World)						
Dimensions (W x H x D)	97 x 97 x 47 mm (3.8" x 3.8" x 1.85")						
Weight (including batteries)	450 g (15.9 ounces)						
AvosetPad Cable Length	2 meters						
Pump Mechanism	Avoset Flex Stroke technology, volumetric pump						
Infusion Modes	Continuous, Intermittent, Taper, PCA						
Accuracy	± 5% per IEC 60601-2-24						
Power Source	3 x AA batteries (disposable/rechargeable)						
Battery Types	Alkaline/LR6 (AA, 1.5V) or NiMH/HR6 (AA, 1.2V)						
Battery Life	Results of laboratory tests conducted at room temperature using new batteries (Duracell Plus AA Alkaline and NiMH Duracell rechargeable NiMH DX1500, respectively). Test were conducted using a water-like fluid with viscosity of 1 cP.						
	<table border="0"> <tr> <td style="padding-right: 20px;">@ 1 mL/h</td> <td>280 hours (alkaline), 270 hours (rechargeable)</td> </tr> <tr> <td>@ 25 mL/h</td> <td>75 hours (alkaline), 70 hours (rechargeable)</td> </tr> <tr> <td>@ 300 mL/h</td> <td>15 hours (alkaline), 12 hours (rechargeable)</td> </tr> </table>	@ 1 mL/h	280 hours (alkaline), 270 hours (rechargeable)	@ 25 mL/h	75 hours (alkaline), 70 hours (rechargeable)	@ 300 mL/h	15 hours (alkaline), 12 hours (rechargeable)
@ 1 mL/h	280 hours (alkaline), 270 hours (rechargeable)						
@ 25 mL/h	75 hours (alkaline), 70 hours (rechargeable)						
@ 300 mL/h	15 hours (alkaline), 12 hours (rechargeable)						
	In laboratory tests in worst-case conditions (5° C), @ 1 mL/h: 250 hours (alkaline) and 240 hours (rechargeable); @ 25 mL/h: 50 hours (alkaline) and 50 hours (rechargeable); @ 300 mL/h: 10 hours (alkaline) and 12 hours (rechargeable). At viscosity of 10.8 cP, no reduction in duration occurred.						
Connectivity	BT, NFC						
Disposable Set	Not made with DEHP; Automatic anti-free-flow protection						
Container	Medication reservoir, bag, syringe						
Ingress Protection	IP34 per IEC 60529						
KVO Rate	Supported, 0.1 mL/h increments						
Flow Rate	0.1–100 mL/h with 0.1 mL/h increments 100–300 mL/h with 1 mL/h increments						
Volume (VTBI)	0.1–9,999 mL with 0.1 mL increments						
Upstream Occlusion	0.4 bar						
Downstream Occlusion Sensitivity Levels	0.5 bar (high), 1.2 bar (medium), and 1.6 bar (low)						
Operating Temperature	5–40° C (35.6–104° F)						
Maximum Infusion Pressure Generated	2 bar						
Priming	Manual or automatic						
Defibrillator-proof (recovery time)	Max 1 second						
Infusion Device	Linear, peristaltic						

Specification	Value
Pump Sensors	<ul style="list-style-type: none"> <li>• Air in line</li> <li>• Upstream/downstream occlusion</li> <li>• Cassette insertion</li> <li>• Temperature: Measures the pump's internal temperature</li> </ul>
Fuse Rating	1.1 A, 16 V
Maximum Effective RF Radiated Power	3.99 dBm
Frequency Band of RF Transmission	2.402–2.480 GHz as Bluetooth
RF Modulation Type	GFSK
Air Detection Sensitivity Levels	Detects both single and accumulated bubbles sized 0.1, 0.2, 0.5, and 2 mL (for single bubble) and 1 mL (for accumulated bubbles). Detectable bubble sizes can be configured using the Avoset Programming Tool.
Expected Service Life (for pump, cradle, and Cassette Lock)	7 years

## Operation Conditions

Operate the Avoset Infusion Pump only within the following parameters:



### Warning

The pump, cradle, and Cassette Lock must operate in the defined temperature specification. Any deviation can affect pump performance.

Condition	Minimum	Maximum
Temperature	5° C (41° F)	40° C (104° F)
Humidity	15% RH	90% RH
Atmospheric Pressure	70 kPa (10.15 psi)	106 kPa (15.4 psi)



### Note

The operation was tested in transient conditions of -20° C (-4° F) and 50° C (122° F) for 10 minutes and found to operate according to specifications.

# Pump Accuracy



## Note

Further technical information and instructions, in addition to this section, may be provided upon request from Eitan Medical.

Infusion under high back-pressure conditions (for example, when using catheters, or other restricting administration set components) may cause the accuracy of the pump flow delivery to deviate from the accuracy stated for normal conditions.

In the Avoset Infusion Pump, as in all infusion systems, external factors may cause fluctuations in rate accuracy. Conditions that can cause flow fluctuations include:

- Fluid characteristics that deviate from water-like characteristics, such as density, viscosity and homogeneity
- Positive and negative pressure, including back pressure
- Environmental temperature above 40 °C or below 5 °C
- Position of the infusion container height
- Pump operation beyond the recommended operating limits

The following tables show accuracy behavior in a wide range of practical use cases, under nominal and boundary conditions.

## Impact of Infusion-Related Parameters on Flow Rate Accuracy at Normal Environmental Conditions

	Range	
<b>Rates (mL/H)</b>	0.1–300	
<b>Accuracy</b>	±5% for the entire range	

	Ranges	
<b>Bolus Volume (mL)</b>	< 0.5 mL	≥ 0.5 mL
<b>Accuracy</b>	±10%	±5%



## Impact of External/Environmental Parameters on Flow Rate Accuracy

Ranges	
<b>Temperature</b>	5–40° C (41–104° F)
<b>Accuracy</b>	±5% for the entire range

Ranges	
<b>Humidity (%)</b>	15–90
<b>Accuracy</b>	±5% for the entire range

Ranges	
<b>Altitude</b>	(-381)–6096 m ((-1210)–20000 ft)
<b>Accuracy</b>	±5% for the entire range

Ranges		
<b>Backpressure (bar)</b>	(-0.2)*–0.4	>0.4–1.35**
<b>Accuracy</b>	±5%	±10%
* For example, if the patient is 2 meters below the pump.		
** For example, when using a long thin catheters.		

Ranges	
<b>Head Height</b>	(-0.2)–0.2 m ((-7.5)–7.5 ft)
<b>Accuracy</b>	±5% for the entire range

## Impact of Viscosity

The following graph shows the required fluid viscosity at different flow rates in order to maintain the delivery accuracy of 5%.

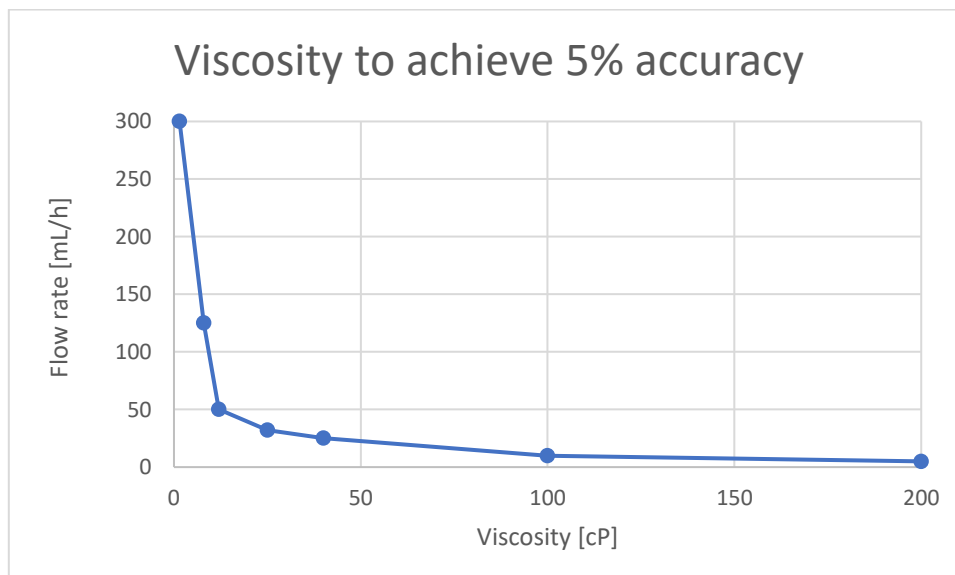

## Post-Occlusion Time and Volume

### Max Time to Occlusion

This table presents the maximum time to a downstream occlusion alarm when an occlusion occurs on the downstream tubing, 1 meter from the cassette:

Occlusion Detection Sensitivity	Infusion Rate (mL/h)	Maximum Time (in minutes) to Downstream Occlusion Alarm for <i>Microbore</i> Tubing	Maximum Time (in minutes) to Downstream Occlusion Alarm for <i>Macrobore</i> Tubing
0.5 bar	25	0.4 (24 seconds)	0.8 (48 seconds)
	1	20	40
	0.1	50	120
1.2 bar	25	0.7 (42 seconds)	1.6 (96 seconds)
	1	25	70
	0.1	50	120
1.6 bar	25	1.2 (72 seconds)	2.2 (132 seconds)
	1	30	90
	0.1	50	120

### Bolus Volume after Downstream Occlusion

This table presents the maximum bolus volume after an occlusion occurred on the downstream Microbore tubing, 1 meter from the cassette:

Occlusion Detection Sensitivity	Infusion Rate (mL/h)	Maximum Bolus Volume (mL) after Occlusion Alarm for <i>Microbore</i> Tubing	Maximum Bolus Volume (mL) after Occlusion Alarm for <i>Macrobore</i> Tubing
0.5 bar	25	0.06	0.1
1.2 bar	25	0.08	0.25
1.6 bar	25	0.1	0.30

## Start-up and Trumpet Graphs

The start-up graphs represent startup flow versus operating time for the first two hours from the start of the infusion. They exhibit the stability of delivery due to mechanical compliance and provide a visual representation of uniformity. Start-up graphs were performed according to the IEC 60601-2-24 standard and followed applicable FDA guidance. Testing was performed under normal conditions (specified in IEC 60601-2-24 standard) at room temperature (22° C, 71.6° F).



### Note

For details of equipment used in testing, contact [support@eitanmedical.com](mailto:support@eitanmedical.com).

Trumpet curves are named for their characteristic /shape, and are developed in accordance with IEC 60601-2-24. They display the percent flow rate deviation from the programmed rate over time. The horizontal axis represents the observation time intervals.

Over long observation windows, short-term fluctuation has little effect on accuracy, as represented by the flat part of the curve. As the observation window is reduced, short-term fluctuations have a greater effect, as represented by the “mouth” of the trumpet.

### Delivery Startup Graph, Second Hour of Test Period, 0.1mL/h

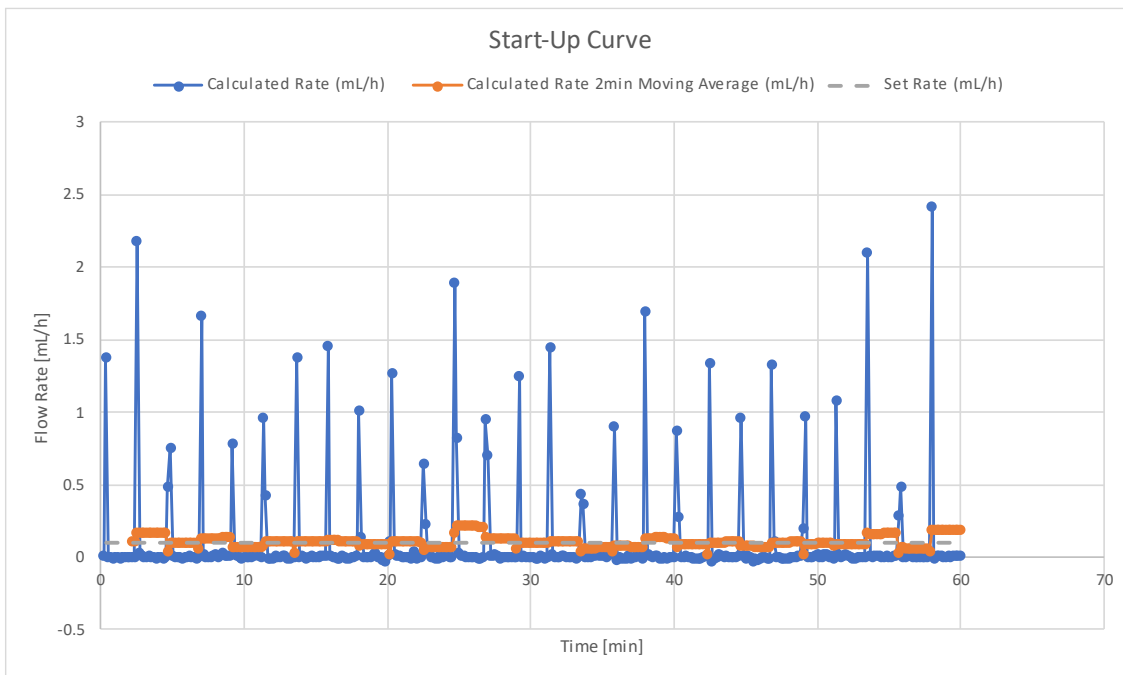

### Trumpet Graph, Second Hour of Delivery, 0.1mL/h

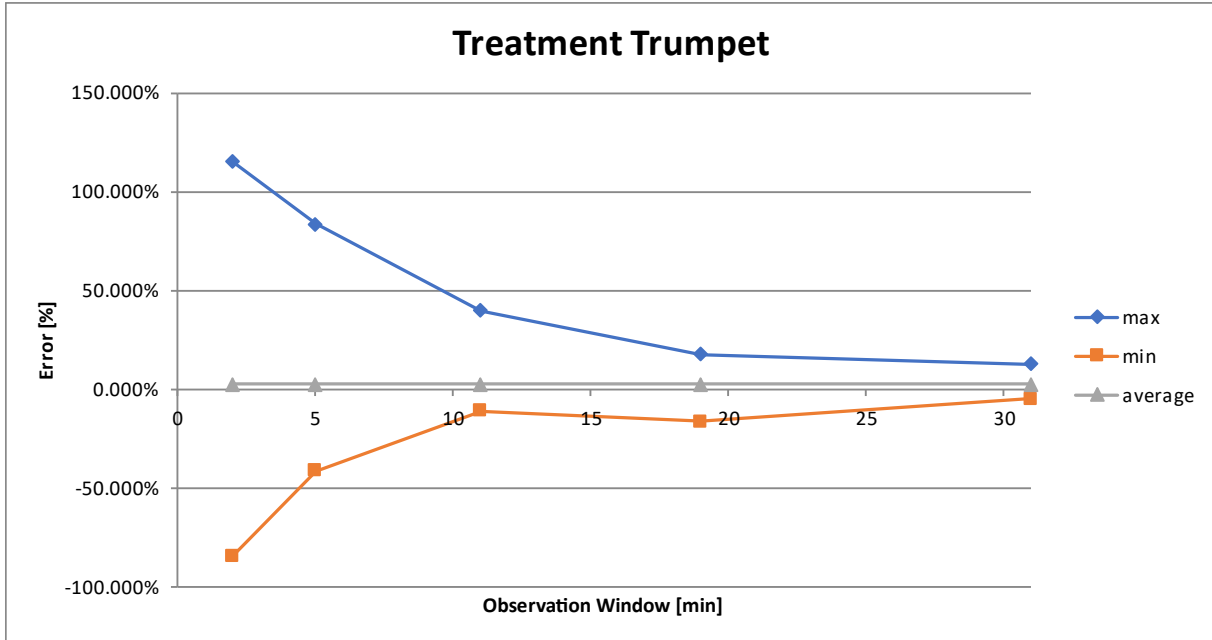

### Delivery Startup Graph, Second Hour of Test Period, 1 mL/h

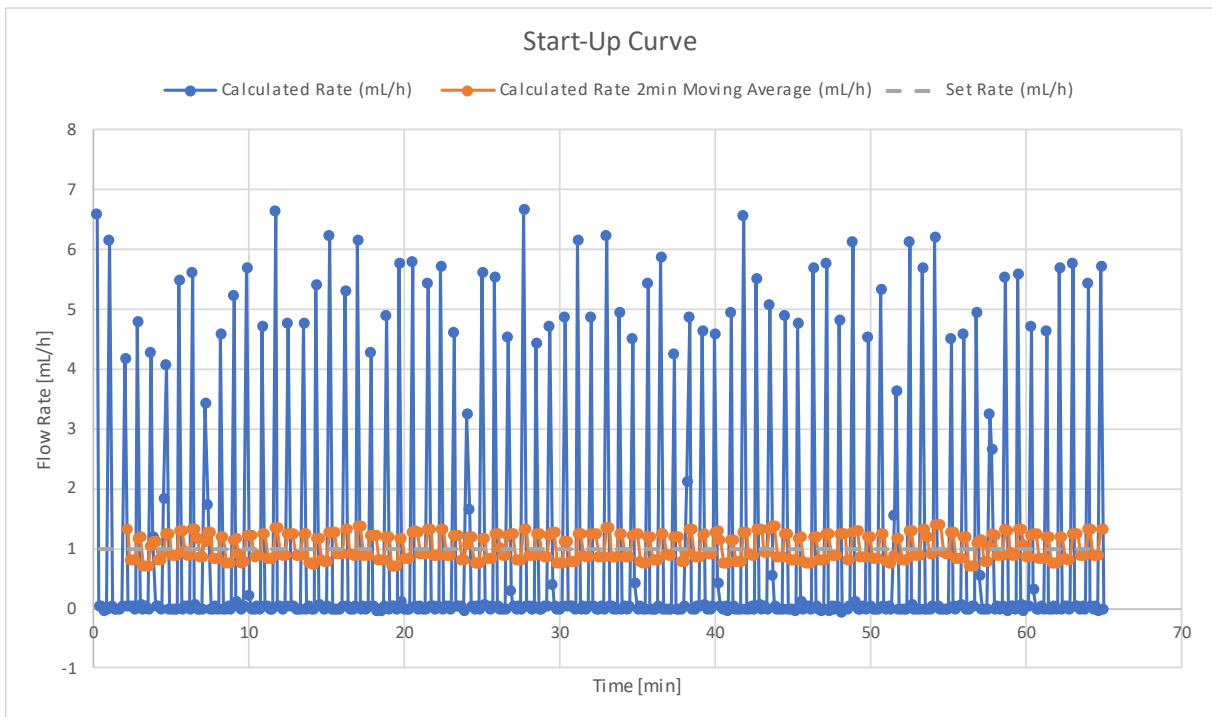

### Trumpet Graph, Second Hour of Delivery, 1 mL/h

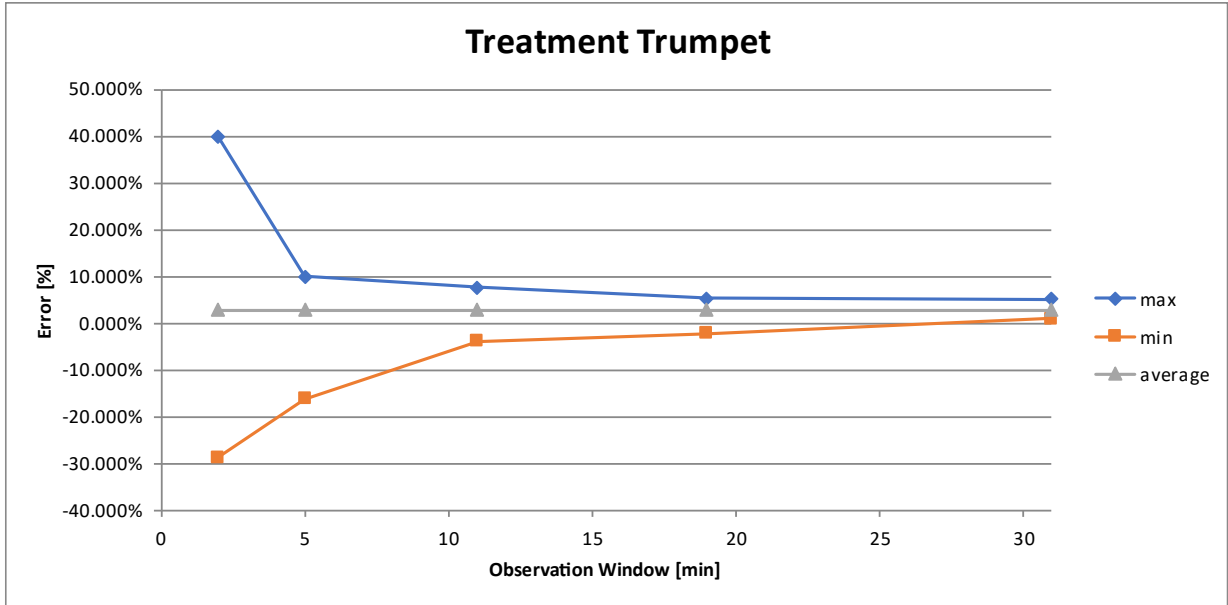

### Trumpet Graph, 96th ( Last) Hour of Delivery, 1 mL/h

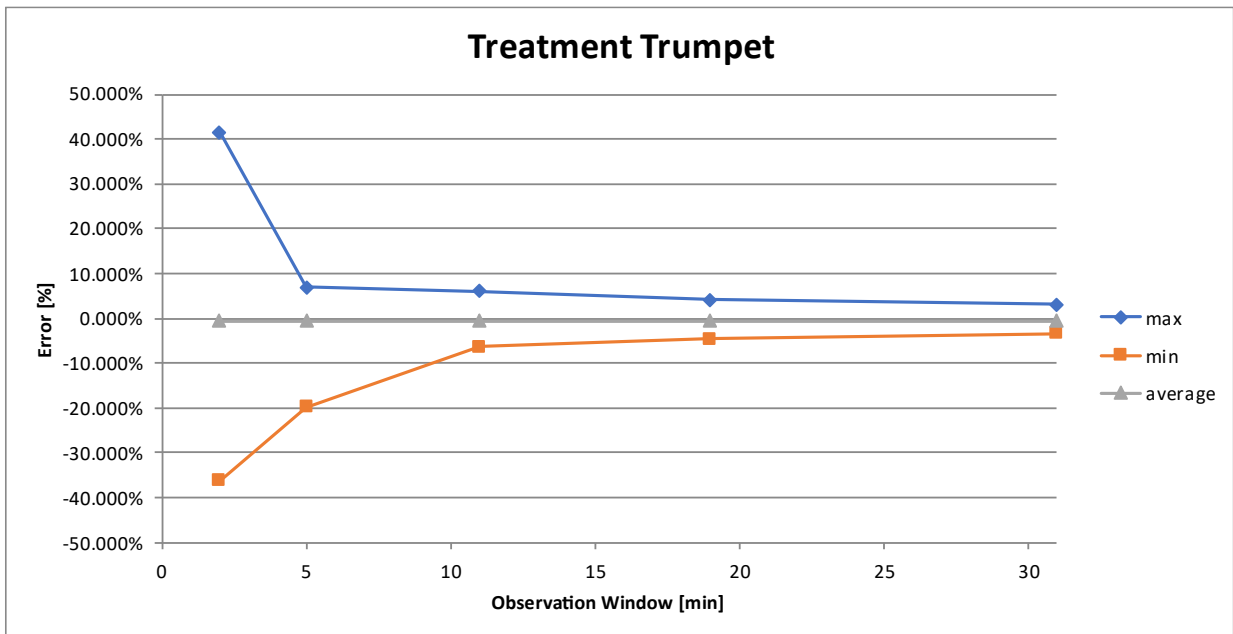

## Delivery Startup Graph, Second Hour of Test Period, 25 mL/h

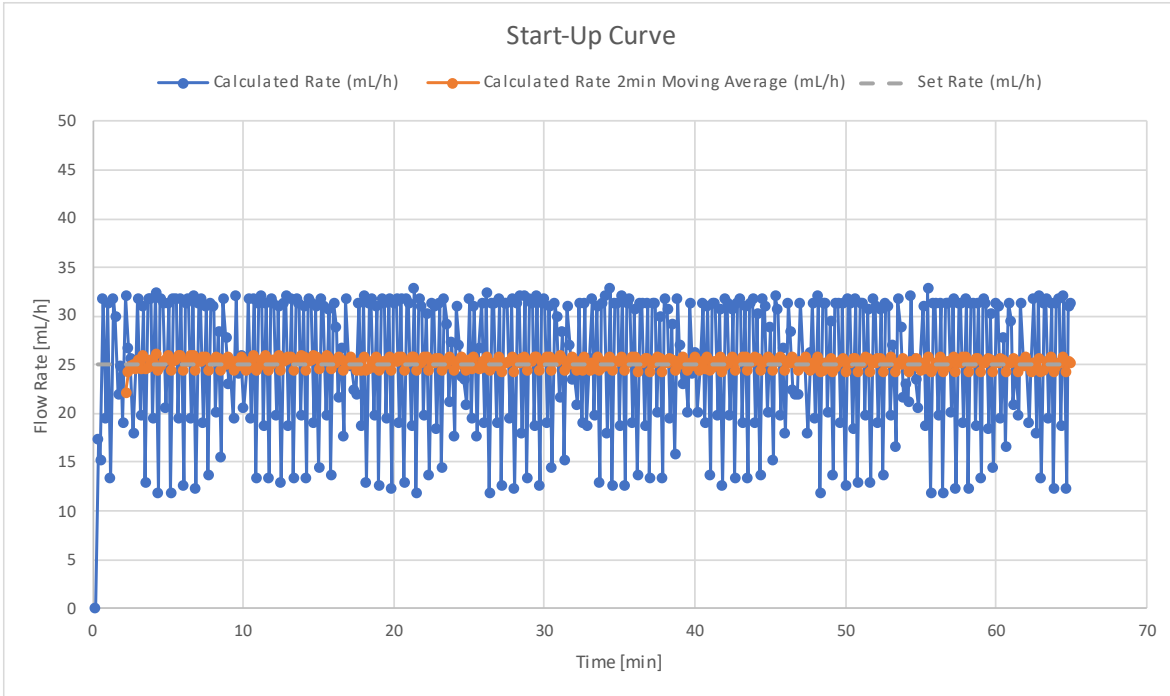

## Trumpet Graph, Second Hour of Delivery, 25 mL/h

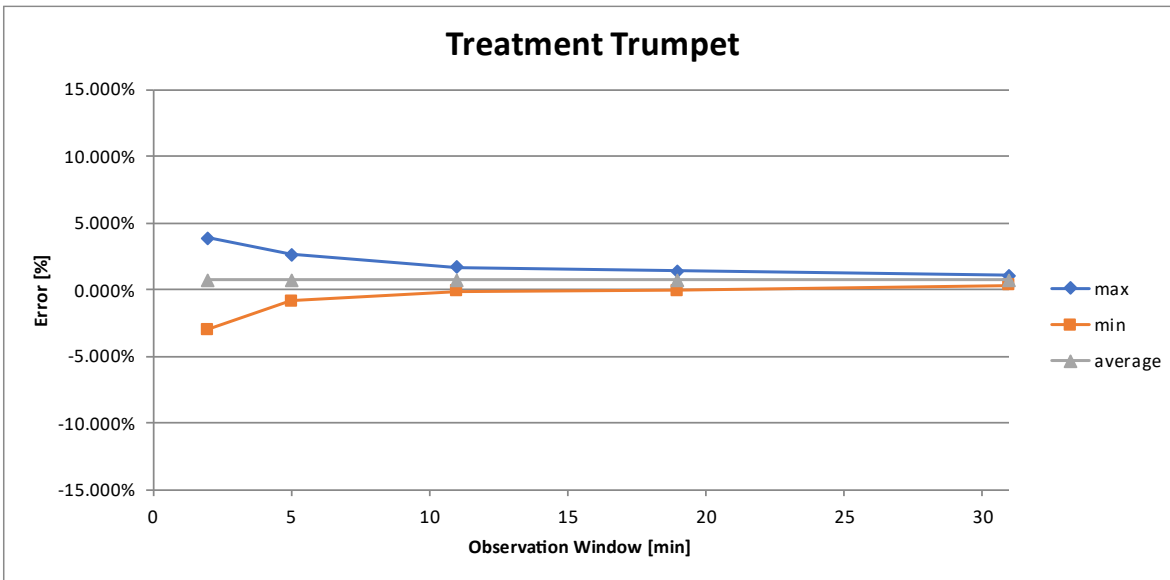

Trumpet Graph, 96th (Last) Hour of Delivery, 25 mL/h

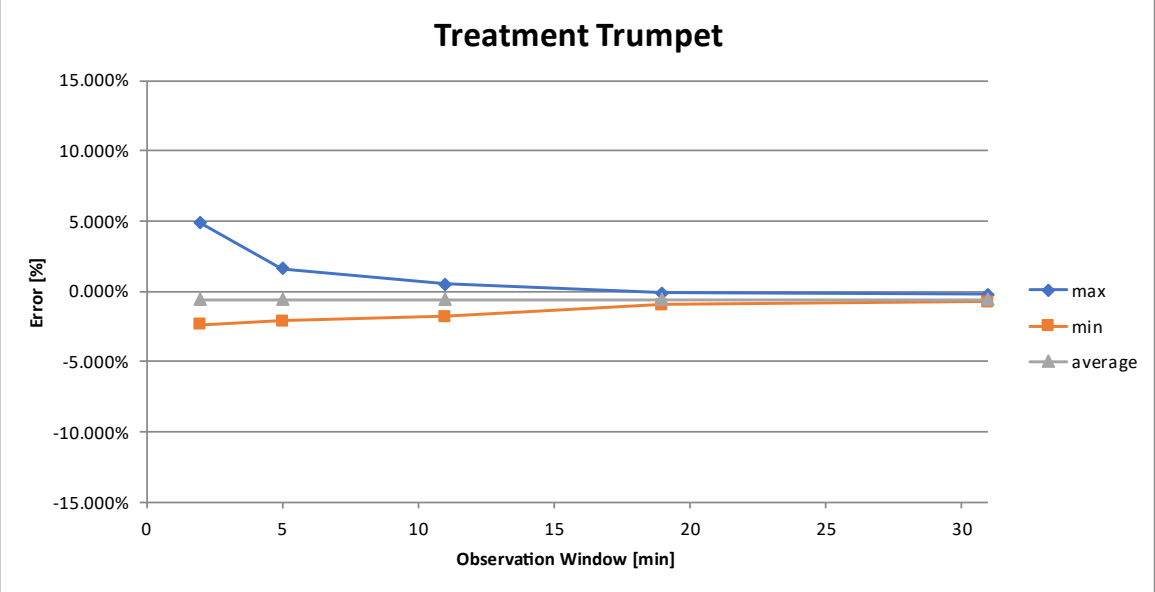

## Advanced Settings

The following tables lists all fields (settings) in the Avoset pump and software that can accessed through the Avoset Programming Tool (for details, see the Avoset Programming Tool User Manual).

The tables provide the following information:

- **Category Name:** The tab in the Pump Default Settings screen where the field is found.
- **Setting Name:** The name of the setting as it appears in the Programming Tool. In some cases, a second name is listed if the field is viewed under specific pump settings, where only fields applicable to that treatment program are displayed.
- **Delivery Mode:** The delivery mode (program type) for which the field is applicable.
- **Factory Default Value:** The factory default.
- **Possible Values or Ranges:** If a field has a set list of values to choose from, they are shown here. Settings with Off/**On** values have a slider control. Minimum and maximum values for the field are shown, if applicable.

## General Settings

These settings are applicable to all program types (delivery modes).

Category Name	Setting Name	Factory Default Value	Possible Values or Ranges (Min. / Max.)
Alarms	Air in Line	2 mL	Off, 0.1, 0.2, 0.5, 2 mL
Alarms	Accumulated Air	Off	Off (0 mL), <b>On</b> (1 mL)
Alarms	Occlusion Sensitivity	Medium	Low (1.6), Medium (1.2), High (0.5)
Alarms	Pump Unattended	10 minutes	2, 5, 10 minutes
Alarms	Time Offset (for using the pump in a different time zone)	0	-6, -5, -4, -3, -2, -1, 0, +1, +2, +3, +4, +5, +6
Alarms	(Intermittent only) Time To Change Bag Reminder	10 minutes	10, 20, 30 minutes
Prime	Prime Reminder	Off	Off, <b>On</b>
Audio	Alarm Volume	High	Low, High
Audio	Keys Volume	Low	Off, Low, High
Passwords	Passwords	298	Min: 100 Max: 999



## Password Protection Settings

These settings are applicable to all password protection parameters as they apply to different program types (delivery modes).

Category Name	Delivery Mode	Setting Name	Factory Default Value	Possible Values or Ranges (Min. / Max.)
Passwords	All	Passwords	***	Min: 100 Max: 999
Passwords	Continuous	Automatic Prime	LOCKED	UNLOCKED, LOCKED
Passwords	Continuous	Edit Infusion	LOCKED	UNLOCKED, LOCKED
Passwords	Intermittent	Automatic Prime	LOCKED	UNLOCKED, LOCKED
Passwords	Intermittent	Edit Next Dose Start Time	LOCKED	LOCKED
Passwords	PCA	Automatic Prime	LOCKED	LOCKED
Passwords	PCA	Clear PCA Bolus History	UNLOCKED	UNLOCKED, LOCKED
Passwords	PCA	Edit Infusion	LOCKED	LOCKED
Passwords	PCA	Clinical Bolus	LOCKED	LOCKED
Passwords	Taper	Automatic Prime	LOCKED	UNLOCKED, LOCKED
Passwords	Taper	Edit Infusion	UNLOCKED	UNLOCKED, LOCKED
Passwords	Taper	Immediate Taper Down	UNLOCKED	UNLOCKED, LOCKED

## Program-specific Settings

### Continuous

Category Name	Setting Name	Factory Default Value	Possible Values or Ranges (Min. / Max.)
Continuous	KVO Rate	0 mL/h	Min: 0.1 mL/h Max: 10 mL/h
Continuous	(*3) Minimum Rate	0.1 mL/h	Min: 0.1 mL/h Max: Max Rate Value
Continuous	(*2) Maximum Rate	300 mL/h	Min: Min Rate Value Max: 300 mL/h
Continuous	(*5) Minimum VTBI	0.1 mL	Min: 0.1 mL/h Max: Max VTBI Value
Continuous	(*4) Maximum VTBI	9999 mL	Min: Min VTBI Value Max: 9999 mL
Continuous	(*5) Minimum VTBI	0.1 mL	Min: 0.1 mL/h Max: Max VTBI Value
Continuous	Dosing Unit	On	Off, On

## Intermittent

Category Name	Setting Name	Factory Default Value	Possible Values or Ranges (Min. / Max.)
Intermittent	Default KVO Rate	empty	Min: Min KVO Max: Max KVO
Intermittent	Default Total Duration	empty	Min: 00h:11m Max: 999h:59m
Intermittent	Default Call-back Before Dose	empty	Min: 00h:05m Max: 1h:00m
Intermittent	Minimum Dose Rate	0.1 mL/h	Min: 0.1 mL/h Max: Max Dose Rate
Intermittent	Maximum Dose Rate	300 mL/h	Min: Min Dose Rate Max: 300 mL/h
Intermittent	Minimum Dose Volume	0.1 mL	Min: 0.1 mL Max: Max Dose Volume
Intermittent	Maximum Dose Volume	999 mL	Min: Min Dose Volume Max: 999 mL
Intermittent	Minimum Dose Duration	00h:01m	Min: 00h:01m Max: Max Dose Duration
Intermittent	Maximum Dose Duration	24h:00m	Min: Min Dose Duration Max: 24h:00m
Intermittent	Minimum Dose Interval	00h:11m	Min: 00h:11m Max: Max Dose Interval
Intermittent	Maximum Dose Interval	96h:00m	Min: Min Dose Interval Max: 96h:00m
Intermittent	Minimum KVO	0.1 mL/h	Min: 0.1 mL/h Max: Max KVO
Intermittent	Maximum KVO	10 mL/h	Min: Min KVO Max: 10 mL/h
Intermittent	Minimum VTBI	0.1 mL	Min: 0.1 mL Max: Max VTBI
Intermittent	Maximum VTBI	9000 mL	Min: Min VTBI Max: 9000 mL
Intermittent	Dosing Unit	On	Off, On

## PCA

Category Name	Setting Name	Factory Default Value	Possible Values or Ranges (Min. / Max.)
PCA	KVO Rate	0 mL/h	Min: 0.1 mL/h Max: 10 mL/h
PCA	(*6) Bolus Rate	125 mL/h	Min: Min Bolus Rate Max: Max Bolus Rate
PCA	Minimum VTBI	0.1 mL	Min: 0.1 mL Max: Max VTBI
PCA	Maximum VTBI	9999 mL	Min: Min VTBI Max: 9999 mL
PCA	Minimum Continuous Rate	0.1 mL/h	Min: 0.1 mL/h Max: Max Continuous Rate
PCA	Maximum Continuous Rate	100 mL/h	Min: Min Continuous Rate Max: 100 mL/h
PCA	Minimum Bolus Volume	0.1 mL	Min: 0.1 mL Max: Max Bolus Volume
PCA	Maximum Bolus Volume	50 mL	Min: Min Bolus Volume Max: 50 mL
PCA	Minimum Lockout Duration	00h:01m	Min: 00h:01m Max: Max Lockout Duration

Category Name	Setting Name	Factory Default Value	Possible Values or Ranges (Min. / Max.)
PCA	Maximum Lockout Duration	24h:00m	Min: Min Lockout Duration Max: 24h:00m
PCA	Minimum Number of Boluses	1 per hour	Min: 1 per hour Max: Max Number of Boluses
PCA	Maximum Number of Boluses	60 per hour	Min: Min Number of Boluses Max: 60 per hour
PCA	Minimum Total Dose Limit	1 mL	Min: 1 mL Max: Max Total Dose Limit
PCA	Maximum Total Dose Limit	9999 mL	Min: Min Total Dose Limit Max: 9999 mL
PCA	Minimum Loading Dose Volume	0.1 mL	Min: 0.1 mL Max: Max Loading Dose Volume
PCA	Maximum Loading Dose Volume	50 mL	Min: Min Loading Dose Volume Max: 50 mL
PCA	Minimum Bolus Rate	0.1 mL/h	Min: 0.1 mL/h Max: Max Bolus Rate
PCA	Maximum Bolus Rate	300 mL/h	Min: Min Bolus Rate Max: 300 mL/h
PCA	Loading Dose	On	Off, On
PCA	Dosing Unit	On	Off, On

## Taper

Category Name	Setting Name	Factory Default Value	Possible Values or Ranges (Min. / Max.)
Taper	Immediate Taper Down	Off	Off, On
Taper	KVO Rate	0 mL/h	Min: 0.1 mL/h Max: 10 mL/h
Taper	Minimum VTBI	10 mL	Min: 10 mL Max: Max VTBI
Taper	Maximum VTBI	9999 mL	Min: Min VTBI Max: 9999 mL
Taper	Minimum Taper Up Duration	00h:10m	Min: 00h:10m Max: Max Taper Up Duration
Taper	Maximum Taper Up Duration	03h:50m	Min: Min Taper Up Duration Max: 03h:50m
Taper	Minimum Taper Down Duration	00h:10m	Min: 00h:10m Max: Max Taper Down Duration
Taper	Maximum Taper Down Duration	03h:50m	Min: Min Taper Down Duration Max: 03h:50m
Taper	Minimum Total Duration	00h:10m	Min: 00h:10m Max: Max Total Duration
Taper	Maximum Total Duration	96h:00m	Min: Min Total Duration Max: 96h:00m
Taper	Minimum Plateau Rate	0.4 mL/h	Min: 0.4 mL/h Max: Max Plateau Rate
Taper	Maximum Plateau Rate	300 mL/h	Min: Min Plateau Rate Max: 300 mL/h

## Event Log

The pump has a log that keep all events monitored by the system. The event log is maintained after the pump is turned OFF.

In a typical infusion, there may be 100 entries. The log can hold 45,000 entries. When this is exceeded, new entries overwrite the oldest entries in the log.

The event log can be accessed via the Avoset Programming Tool after pairing the pump (see the Avoset Programming Tool User Manual).

# Appendix B: Safety and Compliance

## Compliance and Classification

This manual has been written in conjunction with the requirements in the International Standard, IEC 60601-2-24 for Medical Electrical Equipment—Part 2-24: *Particular Requirements for Safety of Infusion Pumps and Controllers*. Data presented in the Technical Specification section reflect specific test conditions defined in this standard. Other external factors, such as varying back pressure, temperature, head height, set usage, fluid restrictions, solution viscosity, or combinations of these factors may result in deviations from the performance data presented.

## Electromagnetic Compatibility Statement



### Note

The Avoset Infusion Pump has not been evaluated for compatibility with Extracorporeal Membrane Oxygenation (ECMO) systems.

The system complies with the following radio standards:

- 2014/30/EU EMCD
- 2014/35/EU LVD
- 2014/53/EU RED

The system complies with the following radio directives:

- EN 301489-17, EN 301489-3
- EN 300 328 V2.1.1, EN 300 330 V2.1.1
- EN 62479
- EU Directive 2015/863
- Regulation (EC) No 1907/2006
- 2012/19/EU

The Avoset Infusion Pump is designed to conform with the electromagnetic compatibility (EMC) standard IEC 60601-1-2 and to operate accurately in conjunction with other medical equipment which also meets the requirements of this standard. To avoid electromagnetic interference that may affect the operation of the pump, do not use the pump near sources of strong electric and magnetic interference (EMI), such as MRI, CT, diathermy, electromagnetic security systems (e.g., metal detectors), radio frequency identification (RFID), electrosurgery devices, lithotripsy devices, and large electric motors.

Portable and mobile RF communication equipment, such as RF emitters, cellular telephones, 2-way radios, Bluetooth devices, and microwave ovens in close proximity to this device may affect wireless communications with the Infusion pump and/or the operation of the Infusion pump.

This device must not be used with any other antenna or transmitter that has not been approved to operate in conjunction with this device.

The Avoset pump uses RF energy only for its internal function. Therefore, its RF emissions are very low and are not likely to cause any interference in nearby electronic equipment.

The Avoset pump is suitable for use in all establishments, including domestic establishments and those directly connected to the public low voltage power supply network that supplies buildings used for domestic purposes.

Some of these EMI sources (mostly RF emitters) may not be visible and the device can potentially be exposed to fields from these EMI sources without the user's awareness. Special precautions need to be exercised regarding EMC. These include:

- Managing the electromagnetic environment to permit the device to perform as intended without disturbing other equipment.



**Note**

When programming the pump, the electromagnetic environment includes a PC.

- Separating the device from all other electronic equipment. If the device must be used near other electrical equipment, monitor the equipment to ensure there is no electromagnetic interference.
- Distancing from RF equipment.



**Caution**

To prevent potential degradation of performance, do not use any part of the pump closer than 30 cm (12 in) from any portable RF communications equipment (including peripherals such as antenna cables and external antennas) as specified here:

Recommended separation distances between portable and mobile RF communications equipment and the Avoset pump.				
Rated maximum output power of transmitter W	Separation distance according to frequency of transmitter m			
	150 kHz to 80 MHz outside ISM bands	150 kHz to 80 MHz in ISM bands	80 MHz to 800 MHz	800 MHz to 2,5 GHz
	$d = \left[ \frac{3,5}{V_1} \right] \sqrt{P}$	$d = \left[ \frac{12}{V_2} \right] \sqrt{P}$	$d = \left[ \frac{12}{E_1} \right] \sqrt{P}$	$d = \left[ \frac{23}{E_1} \right] \sqrt{P}$
0.01	0.12	0.2	0.4	1
0.1	0.37	0.64	1.3	2.6
1	1.17	2	4	8
10	3.7	6.4	13	26
100	11.7	20	40	80

- Stacking or placement.
- 



### **Caution**

Use of this equipment adjacent to or stacked with other equipment should be avoided as it could result in improper operation. If such use is necessary, this equipment and the other equipment should be observed to verify that they are operating normally.

---

- Devices should not be used adjacent to or stacked with other equipment. If the device must be used adjacent to or stacked with other equipment, monitor the device to verify normal operation.
- If you identify or suspect that external RF sources or other equipment are influencing device operation (from known or unknown sources), try to (as applicable) increase the pump's distance from the EMI source, re-orient the device, relocate the device, connect the device to a different outlet, contact the biomedical engineering department for additional guidelines concerning electromagnetic immunity or decrease emitting device output power (to 30 dBm).

The EMC limits for the Medical Device Regulation 2017/745 of the European Communities concerning medical devices are designed to provide reasonable protection against harmful interference in a typical medical installation. The equipment generates, uses and can radiate, radio frequency energy, and if not installed and used in accordance with the instructions, may cause harmful interference to other devices in the vicinity. However, there is no guarantee that interference will not occur in a particular installation. If this equipment does cause harmful interference with other devices, which can be determined by turning the equipment OFF and ON, the user is encouraged to try to correct the interference by one or more of the following measures:

- Reorient or relocate the receiving device
  - Increase the distance separating between the equipment parts
  - Consult the manufacturer or field service technician for help
- 



### **Electromagnetic Safety Precautions**

- Do not expose the pump to therapeutic levels of ionizing radiation, as permanent damage to the pump electronic circuitry may occur. It is preferable to remove the pump from the patient during therapeutic radiation sessions.
  - Do not use the pump in the vicinity of magnetic resonance imaging (MRI) equipment, as magnetic fields may adversely affect the operation of the pump. Remove the pump from the patient during MRI procedures, and keep it at a safe distance from magnetic energy.
  - Use of accessories, transducers, and cables other than those specified or provided by the manufacturer of this equipment could result in increased electromagnetic emissions or decreased electromagnetic immunity of this equipment and result in improper operation.
-

## Identification Numbers

The FCC ID and IC number appear on the back of the pump.

FCC ID	2A3JW-AVOSET52840
IC Number	27442- AVOSET52840
For Canada	Can ICES-003(B)
HW Version Number	HVIN: 0.2
SW Version Number (change set)	1.0.0.65250

## Class B Warnings

### FCC Statement

This equipment has been tested and found to comply with the limits for a Class B digital device, pursuant to Part 15 of the FCC rules. These limits are designed to provide reasonable protection against harmful interference in a residential installation. This equipment generates, uses and can radiate radio frequency energy and, if not installed and used in accordance with the instructions, may cause harmful interference to radio communications. However, there is no guarantee that interference will not occur in a particular installation. If this equipment does cause harmful interference to radio or television reception, which can be determined by turning the equipment off and on, the user is encouraged to try to correct the interference by one or more of the following measures:

- Reorient or relocate the receiving antenna.
- Increase the separation between the equipment and receiver.
- Connect the equipment to an outlet on a circuit different from that to which the receiver is connected.
- Consult the dealer or an experienced radio/TV technician.

### CAN ICES-3 (B) / NMB-3 (B)

This Class B digital apparatus complies with Canadian ICES-003.

*Cet appareil numérique de classe B est conforme à la norme canadienne ICES-003.*

In order to maintain compliance with FCC regulations, shielded cables must be used with this equipment. Operation with non-approved equipment or unshielded cables is likely to result in interference to radio and TV reception.



## Modification Statements and FCC/ ISED Regulatory Notices

### FCC Warning

Modifications not expressly approved by the manufacturer could void the user's authority to operate the equipment under FCC Rules.

### ISED Warning

*Eitan Medical n'approuve aucune modification apportée à l'appareil par l'utilisateur, quelle qu'en soit la nature. Tout changement ou modification peuvent annuler le droit d'utilisation de l'appareil par l'utilisateur.*

### Interference Statement

This device complies with Part 15 of the FCC Rules and Industry Canada licence-exempt RSS standard(s). Operation is subject to the following two conditions: (1) this device may not cause interference, and (2) this device must accept any interference, including interference that may cause undesired operation of the device.

*Le présent appareil est conforme aux CNR d'Industrie Canada applicables aux appareils radio exempts de licence. L'exploitation est autorisée aux deux conditions suivantes : (1) l'appareil ne doit pas produire de brouillage, et (2) l'utilisateur de l'appareil doit accepter tout brouillage radioélectrique subi, même si le brouillage est susceptible d'en compromettre le fonctionnement.*

### Wireless Notice

This device complies with FCC/ISED radiation exposure limits set forth for an uncontrolled environment and meets the FCC radio frequency (RF) Exposure Guidelines and RSS-102 of the ISED radio frequency (RF) Exposure rules. This transmitter must not be co-located or operating in conjunction with any other antenna or transmitter.

*Le présent appareil est conforme à l'exposition aux radiations FCC / ISED définies pour un environnement non contrôlé et répond aux directives d'exposition de la fréquence de la FCC radiofréquence (RF) et RSS-102 de la fréquence radio (RF) ISED règles d'exposition. L'émetteur ne doit pas être colocalisé ni fonctionner conjointement avec à autre antenne ou autre émetteur.*

## Electromagnetic Emission

The Avoset Infusion Pump is intended for use in the electromagnetic environment specified below. The user of the pump should ensure that it is used in such an environment.



### Caution

Use of accessories, transducers, and cables other than those specified or provided by the manufacturer of this equipment could result in increased electromagnetic emissions or decreased electromagnetic immunity of this equipment and result in improper operation.

Emission Test	Compliance	Electromagnetic Environmental Guidance
RF Emission	CISPR 11 class B	The pump is suitable for use in home and clinical environment.

## Electromagnetic Immunity

The Avoset Infusion Pump is intended for use in the electromagnetic environment specified below.

The user should ensure that it is used in the following environment.



### Caution

Use of this equipment adjacent to or stacked with other equipment should be avoided because it could result in improper operation. If such use is necessary, this equipment and the other equipment should be observed to verify that they are operating normally.

Test Method	Test Level	Compliance Level	Electromagnetic Environmental Guidance
Electrostatic discharge (ESD) per IEC 61000-4-2	±8 kV contact, ±2 kV, ±4 kV, ±8 kV, ±15 kV air*	±8 kV contact, ±2 kV, ±4 kV, ±8 kV, ±15 kV air*	Floors should be wood, concrete or ceramic tile. If floors are covered with synthetic material, the relative humidity should be at least 30%.
Radiated RF EM field immunity per IEC 61000-4-3	10 V/m, 80 MHz –2.7 GHz, 80 % AM at 1 kHz*	10 V/m, 80 MHz –2.7 GHz, 80 % AM at 1 kHz	N/A
Power frequency (50/60 Hz) magnetic field immunity per IEC 61000-4-8	30 A/m*	30 A/m	Power frequency magnetic fields should be at levels characteristic of a typical location in a typical commercial or hospital environment
RF wireless communications equipment fields Immunity per IEC 61000-4-3	Frequencies and levels as specified at IEC 60601-1-2, Table 9*	Max. 28 V/m	N/A
Radiated Emission CISPR 11/ IEC 60601-1-2	Category B	30MHz -6GHz	N/A

Test Method	Test Level	Compliance Level	Electromagnetic Environmental Guidance
Radiated Immunity - RTCA DO-160G Section 20 (RF immunity, e.g., category R)	As specified in section 20.5 of RTCA DO-160G	As specified in section 20.5 of RTCA DO-160G – maximum 150 V/m	N/A
* The pump was tested according to the EMC requirements of IEC 60601-1-2 (fourth edition).			

Immunity Test	IEC 60601 Test Level	Compliance Level	Electromagnetic Environmental Guidance
Conducted RF IEC 61000-4-6	10V/m  3V from 0.15 to 80MHz; 6V from 0.15 to 80MHz and 80% AM at 1kHz	10V/m  3V from 0.15 to 80MHz; 6V from 0.15 to 80MHz and 80% AM at 1kHz	<p>Portable and mobile RF communications equipment should be used no closer to any part of the Avoset pump, including cables, than the recommended separation distance calculated from the equation applicable to the frequency of the transmitter.</p> <p>Recommended separation distance</p> $d = \left[ \frac{3,5}{V_1} \right] \sqrt{P}$ $d = \left[ \frac{12}{V_2} \right] \sqrt{P}$ $d = \left[ \frac{12}{E_1} \right] \sqrt{P} \quad 80 \text{ MHz to } 800 \text{ MHz}$ $d = \left[ \frac{23}{E_1} \right] \sqrt{P} \quad 800 \text{ MHz to } 2,5 \text{ GHz}$ <p>where P is the maximum output power rating of the transmitter in watts (W) according to the transmitter manufacturer and d is the recommended separation distance in meters (m).</p> <p>Field strengths from fixed RF transmitters, as determined by an electromagnetic site survey, should be less than the compliance level in each frequency range.</p> <p>D Interference may occur in the vicinity of equipment marked with the following symbol:</p> 
Radiated RF IEC 61000-4-3	10V/m from 80MHz to 2.7GHz	10V/m from 80MHz to 2.7GHz	

Proximity magnetic fields IEC 61000-4-39	8 A/m (30 kHz, CW)	8 A/m (30 kHz, CW)	N/A
	65 A/m (134.2 kHz, pulse modulation 2.1 kHz)	65 A/m (134.2 kHz, pulse modulation 2.1 kHz)	
	7.5 A/m (13.56 MHz, pulse modulation 50 kHz)	7.5 A/m (13.56 MHz, pulse modulation 50 kHz)	

Test specifications for ENCLOSURE PORT IMMUNITY to proximity magnetic fields – per IEC 60601-1-2 Ed. 4.1		
Test frequency	Modulation	Immunity Test Level (A/m)
30 kHz	CW	8
134,2 kHz	Pulse modulation 2.1 kHz	65
13,56 MHz	Pulse modulation 50 kHz	7.5

Test specifications for ENCLOSURE PORT IMMUNITY to RF wireless communications equipment							
Test Frequency (MHz)	Band <sup>a)</sup> (MHz)	Service <sup>a)</sup>	Modulation <sup>b)</sup>	Maximum Power (W)	Distance (m)	Immunity Test Level (V/m)	Compliance Level (V/m)
385	380 – 390	TETRA 400	Pulse modulation <sup>b)</sup> 18 Hz	1.8	0.3	27	27
450	430 – 470	GMRS 460, FRS 460	FM <sup>c)</sup> ± 5 kHz deviation 1 kHz sine	2	0.3	28	28
710 745 780	704 – 787	LTE Band 13, 17	Pulse modulation <sup>b)</sup> 217 Hz	0.2	0.3	9	9
810 870 930	800 – 960	GSM 800/900, TETRA 800, iDEN 820, CDMA 850, LTE Band 5	Pulse modulation <sup>b)</sup> 18 Hz	2	0.3	28	28
1720 1845 1970	1 700 – 1 990	GSM 1800; CDMA 1900; GSM 1900; DECT; LTE Band 1, 3, 4, 25; UMTS	Pulse modulation <sup>b)</sup> 217 Hz	2	0.3	28	28
2450	2 400 – 2 570	Bluetooth, WLAN, 802.11 b/g/n, RFID 2450, LTE Band 7	Pulse modulation <sup>b)</sup> 217 Hz	2	0.3	28	28
5240 5500 5785	5 100 – 5 800	WLAN 802.11 a/n	Pulse modulation <sup>b)</sup> 217 Hz	0.2	0.3	9	9
<sup>a)</sup> For some services, only the uplink frequencies are included. <sup>b)</sup> The carrier shall be modulated using a 50 % duty cycle square wave signal. <sup>c)</sup> As an alternative to FM modulation, 50 % pulse modulation at 18 Hz may be used because while it does not represent actual modulation, it would be worst case.							

## Applicable IEC Classifications

<b>IEC 60601-1</b>	Medical Electrical Equipment: <ul style="list-style-type: none"><li>internally powered</li><li>Class II</li><li>Type CF</li><li>Continuous operation</li><li>IP34 dust- and splash-proof</li><li>Not suitable for use in the presence of flammable anesthetic mixture with air or with oxygen or nitrous oxide</li></ul>
<b>IEC 60601-1-2</b>	Electromagnetic compatibility.
<b>IEC 60601-2-24</b>	Infusion pumps and controllers, which classifies the Avoset Infusion Pump as a Type 1 and Type 3 pump (continuous infusion flow, combined with bolus delivery).
<b>IEC 60601-1-8</b>	Requirements for alarm systems in medical electrical equipment and medical electrical systems.
<b>IEC 60601-1-11</b>	Requirements for medical electrical equipment and medical electrical systems used in the home healthcare environment. Note: The Avoset pump, with or without its Cassette Lock, cradle, and administration set, is transit-operable and may be attached to a wheelchair or used in vehicles (e.g. car, bus, train, or plane). The pump and the Cassette Lock can also be body-worn or hand-held and used while walking or otherwise moving around, sometime outside of the home.

## Other Compliance

### Defibrillator Compliance Statement

The Avoset Infusion Pump is equipment type CF Applied Part, due to its administration set that is connected to the patient.

### CISPR 11 Classification

The Avoset Infusion Pump is classified as a Class B ME and is meant to be operated in domestic establishments connected to a low voltage power supply network that does not emit strong radio-frequency.

### Biocompatibility

All materials in components of the administration sets that are in the fluid pathway have been tested for biocompatibility and are in compliance with applicable international standards ISO 10993-series for biocompatibility.

### Degree of Protection Against Ingress of Water and Dust















The Avoset Infusion Pump meets the IP34 splash/dust requirements.







### Recycling & Disposal

Dispose of the pump in accordance with local regulations.

## Symbols and Labelling

The following table describes the labels and symbols that appear on the pump, accessories, and packaging.

Symbol	Symbol Title	Location	Description
	Storage Temperature Range	packaging	Safe temperature range for storing packaged device.
	Storage Humidity Range	packaging	Safe humidity range for storing packaged device.
	Atmospheric Pressure Range	packaging	Safe atmospheric pressure range for packaged device.
	Keep Dry	packaging	Product is not waterproof. Keep product dry.
	This Side Up	packaging	Do not store on side or upside down.
	Fragile	packaging	Fragile; handle with care.
	Do not use if package is damaged	packaging	Indicates a medical device that should not be used if the package has been damaged or opened.
	Direct Current	pump back	The device uses electrical direct current.
<b>SN</b>	Serial Number	pump back	Serial number for the specific device (unique to each).
<b>REF</b>	Catalog Number	pump back	Indicates the manufacturer's catalog number so that the medical device can be identified.
	Consult Instructions for Use	Cradle label and Cassette Lock label	Indicates the need for the user to consult the instructions for use.
	Safety (Read Instructions)	pump back	Consulting the accompanying documents is mandatory.
	Date of Manufacture	pump back	Date that the device was produced.
	Manufacturer	pump back	Indicates the name and address of the device manufacturer.
	Defibrillation-proof	pump back	Indicates the device is defibrillation-proof and the degree of protection against electric shock. Equipment type CF applied part.
<b>IP 34</b>	Ingress Protection	pump back	Indicates the device is protected from water spray from any direction.
<b>GTIN</b>	Global Trade Item Number	pump back	Identifying number for these devices.
	Electrical and electronic waste	pump back	Dispose of according to local ordinances.

Symbol	Symbol Title	Location	Description
	MR Unsafe	pump back	Keep away from magnetic resonance imaging (MRI) equipment. The device presents a projectile hazard.
	FCC Logo	pump back	FCC symbol.
	Medical Device	pump back	The device is a medical device.
	Batch Code	pump back	Indicates the manufacturer's batch code so that the batch or lot can be identified.
Rx Only	Prescription	pump back	US Federal law restricts this device to prescription only.
	Battery Orientation	inside pump battery compartment	Shows orientation to insert AA batteries.
	Caution	documentation	Indicates the need for the user to consult the instructions for use for important cautionary information such as warnings and precautions that cannot, for a variety of reasons, be presented on the medical device itself.