

# INSIGNIS™ SYRINGE INFUSION SYSTEM

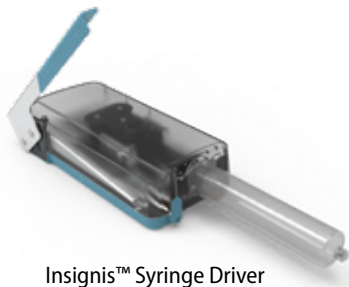

Insignis™ Syringe Driver



Intravenous Controller



OneSett™ Subcutaneous Administration Set



Insignis-26G™ Subcutaneous Needle Sets

## INSTRUCTIONS FOR USE

### Contents

	Introduction to the Insignis™ Syringe Infusion System .....	Page 2	
	Indications for Use .....	Page 2	
	Contraindications .....	Page 2	
	Precautions and Warnings .....	Page 3	
	Cautions .....	Page 3	
INTRAVENOUS	Intravenous Product Diagrams .....	Page 5	
	Intravenous Infusions Using the Intravenous Controller .....	Page 6	
	Ending the Infusion .....	Page 7	
	Troubleshooting .....	Page 8	
	Flow Rate Compensation .....	Page 9	
	Use of the Insignis™ System .....	Page 9	
	Testing and Calibration .....	Page 9	
	SUBCUTANEOUS	Subcutaneous Product Diagrams .....	Page 10
		Subcutaneous Infusions Using the OneSett™ Subcutaneous Administration Set .....	Page 11
		Priming the Administration Set Using the Insignis™ Syringe Driver .....	Page 13
Ending the Infusion .....		Page 14	
Troubleshooting .....		Page 15	
Flow Rate Compensation Using the OneSett™ .....		Page 15	
Care and Maintenance .....		Page 16	
Storage and Use .....		Page 16	
Checking Infusion Progress .....		Page 16	
Stopping the Infusion .....		Page 16	
Notes for Clinicians and Users .....	Page 17		
Flow Rate Time Chart .....	Page 20		
Insignis™ Syringe Infusion System Flow Profile .....	Page 20		
Insignis™ Technical Information .....	Page 21		
Product Identifiers .....	Page 21		
Warranty Information .....	Page 22		
Definition of Symbols .....	Page 22		
References .....	Page 22		

# INSTRUCTIONS FOR USE

## Introduction to the Insignis™ Syringe Infusion System

The Insignis™ Syringe Infusion System is intended for the intravenous infusion of fluids such as 0.9% Sodium Chloride (normal saline) and dextrose solutions, and the following antibiotics when used according to the FDA approved drug product labeling: vancomycin, ertapenem, meropenem, oxacillin, and tobramycin and the subcutaneous infusion of fluids of the following human plasma-derived immunoglobulins when used according to the FDA approved biologic labeling: Cuvitru®, Immune Globulin Infusion (Human) 20% (manufactured by Takeda®); Hizentra®, Immune Globulin Subcutaneous (Human) 20% Liquid (manufactured by CSL Behring®); and Xembify®, Immune Globulin Subcutaneous (Human) 20% Liquid (manufactured by Grifols®). The System consists of a syringe based, non-electric, portable 13.5psi constant pressure syringe driver (using 50ml BD® syringe #309653) with carrying case and intravenous or subcutaneous selectable rate flow control device.

For the intravenous administration of medication(s), the Intravenous (IV) Controller includes a selectable rate flow dial and tubing for direct connection to IV catheter tubing.\*

For the administration of subcutaneous immunoglobulin (SCIg), the OneSett™ Subcutaneous Administration Set comes pre-assembled and includes a selectable rate flow controller, connected directly to an administration set comprised of one (1) to up to four (4) needle set configurations to meet the drug manufacturer's maximum flow rate limits.

### **Subcutaneous accessories are only intended for use with immunoglobulins.**

The Insignis™ Syringe Infusion System's IV Controller and OneSett™ Subcutaneous Administration Set provide the user with the ability to select, titrate, or modify the flow rate in real-time. For example, the OneSett™ enables a patient on subcutaneous immunoglobulin to customize their infusion therapy by simply by turning the flow dial to modify the flow rate. The system will respond to increasing resistance at the infusion site by decreasing the flow rate, however some patients benefit from the decreasing the rate further. Likewise, for intravenous applications, the system will slow the flow rate in response to any increase in venous back pressure. This may minimize infiltration and therefore reduce the risk of overflow or overdose.<sup>1</sup> Users should only adjust the controller flow rates according to the instructions from their healthcare provider.

## Indications for Use

The Insignis™ Syringe Infusion System is specifically indicated for the subcutaneous infusion of the following human plasma-derived immunoglobulins when used according to the FDA approved biologic labeling: Cuvitru®, Immune Globulin Infusion (Human) 20% (manufactured by Takeda®); Hizentra®, Immune Globulin Subcutaneous (Human) 20% Liquid (manufactured by CSL Behring®); and Xembify®, Immune Globulin Subcutaneous (Human) 20% Liquid (manufactured by Grifols®) in the home, hospital, or ambulatory settings when administered according to the approved biologic or drug product labeling. The system is intended for use by clinicians and lay users. It is intended for use in adults and in adolescents ages 13-21. For adolescents, it is to be operated under the supervision of an adult after instruction is provided by a healthcare provider.

The Insignis™ Syringe Infusion System with the Insignis Syringe Driver and Intravenous Controller, is specifically indicated for the intravenous infusion of fluids such as 0.9% Sodium Chloride (normal saline) and dextrose solutions, and the following antibiotics when used according to the FDA approved drug product labeling: vancomycin, ertapenem, meropenem, oxacillin, and tobramycin.

The Insignis™ Syringe Infusion System consists of the following components:

- Insignis Syringe Driver
- Intravenous Controller
- OneSett Subcutaneous Administration Set

The Insignis Syringe Driver is indicated for use with the BD® 50 ml syringe (US Reference number 309653).

## Contraindications

The Insignis™ Syringe Infusion System is not intended for the delivery of life sustaining medications, such as blood transfusion or the delivery of insulin.

\*Intravenous catheter not included. Consult your provider and/or manufacturer's instructions for use for additional information.

## Precautions and Warnings

- The administration sets are single use only. Do not re-sterilize.
- Innovative Health Sciences advises against off-label use of the Insignis™ Syringe Infusion System.
- Do not perform the infusion without the Insignis Syringe Driver.
- Avoid getting the syringe driver wet.
- Carefully inspect all components of the syringe driver before use to verify that it is in working condition. Do not use the syringe driver if it is damaged.
- Do not use if any contaminants, debris, or fluids, including drug residue and/or any cleaning solutions are inside the syringe driver.
- Clean the syringe driver thoroughly after every 30 uses or as needed. Refer to the Care and Maintenance of the Syringe Driver section on page 16 of this manual for cleaning instructions.
- Ensure the syringe is empty before removing the syringe from the syringe driver. If medication is still in the syringe, activate the lever once or as needed to infuse the remaining medication.
- Do not stretch or kink the delivery administration set tubings.
- For any drugs that require filtering, it is recommended to pre-filter the drug prior to beginning the infusion. Consult the drug manufacturer's prescribing information.
- Avoid direct contact with drugs/medications.
- The Insignis accessories are designed to work together as a system to provide specific performance. Do not use any other flow control devices and/or administration sets that are not manufactured by Innovative Health Sciences, as there can be no assurance that the specified performance is maintained and patient harm could occur.
- The Intravenous Controller and the OneSet™ Subcutaneous Administration set are designed for accurate delivery with a 13.5psi constant pressure syringe driver, such as the Insignis™ syringe driver. IHS cannot assure the accurate and consistent delivery of 13.5psi for any other marketed devices. The IV Controller is calibrated for flow rates between 30ml/hr (lowest) to 250ml/hr (highest). There is a KVO feature on the IV Controller for fluids such as normal saline and dextrose. The OneSet is calibrated for flow rates between 10ml/hr/site (lowest) to 60ml/hr/site (highest) for the number of needles required (1-4 set configurations).
- Failure to store the administration sets in the correct storage conditions may cause leakage in the flow controller.
- Use caution when activating the syringe driver's lever to ensure that a finger does not get pinched between the lever and the body of the driver.
- Do not place excessive force on syringe or syringe driver enclosure.

### Caution

- U.S. federal law restricts this device to sale by or on the order of a physician .
- Use of the Insignis™ Syringe Infusion System is intended only for the patient for whom the device is prescribed.
- If using the administration set for the first time, do so in the presence of a healthcare provider. Use this device only after receiving training from a healthcare provider.
- Use only recommended Becton Dickinson and Company® 50ml #309653 syringes with the Insignis Syringe Infusion System.
- Before use, carefully inspect the administration set package. Do not use if the package has been opened or is damaged.
- Always follow the infusion instructions located within the drug's package insert.
- Verify the drug volume in the syringe(s) prior to beginning the infusion and at the end of the infusion.
- The syringe driver's recommended operating temperature is room temperature (68°-77°F or 20°- 25°C).
- Store infusion sets and syringe driver in a cool, dry place.
- Do not leave infusion sets in direct sunlight or inside a vehicle.
- Follow cleaning steps for the syringe driver on page 16 to thoroughly clean the device.
- If the safety lock tab on the syringe driver is inadvertently released and the infusion is halted, return the safety tab to the locked position and activate the lever once for every 10ml (or less) of medication left in the syringe.
- If problems are encountered during use, see the "Troubleshooting" section of this manual (Intravenous: page 8; Subcutaneous: page 15).
- Inspect injection site(s) periodically.

## **Caution**

- If for any reason you experience a medical emergency during use, call the local emergency number and/or your healthcare provider immediately.
- To stop the flow immediately, disengage the safety lock tab on the syringe driver by turning it to the horizontal position (unlocked). You may also use the slide clamp and/or set the flow dial to 0ml/hr (for Intravenous Controller and OneSett™ Subcutaneous Administration Set) to stop the flow.
- Overuse of the slide clamps on the administration sets may damage the tubing and affect the infusion flow rate.
- MRI Unsafe: The Insignis™ Syringe Infusion System has not been tested in a Magnetic Resonance Imaging (MRI) environment and therefore cannot be recommended for use in such an environment.
- The Insignis™ Syringe Infusion System will operate silently from beginning to end of infusion; there are no alarms that will sound and no digital display of the infusion status.
- The Insignis™ System is not suitable for use with medication where delay or under-infusion could result in serious injury.

### *Cautions Specific to Intravenous Use*

- The Intravenous Controller is calibrated for flow rates between 30 ml/hr (lowest) to 250 ml/hr (highest). There is a KVO feature on the IV Controller for fluids such as normal saline and dextrose.
- Do not use the Intravenous Controller KVO setting to infuse medications; use only to infuse fluids such as 0.9% Sodium Chloride (normal saline) and dextrose solutions.
- For intravenous applications, consult the manufacturer of the intravenous catheter set or needle-free adapter for specific instructions for use.
- If there is a problem with the catheter, consult the catheter manufacturer and/or instructions for use and notify your physician.
- Prime the set before connecting to the patient's IV catheter. Disconnect the administration set prior to attempting to free a clogged tubing.
- Place syringe driver at the same height level as the injection port, if possible.

### *Cautions Specific to Subcutaneous Immunoglobulin Use*

- Use of flow rate calculation software and/or computation documentation (tables, charts, graphs, etc.) is not required for use with the OneSett™ Subcutaneous Administration Set as the flow rate indication appears directly on the dial.
- If a needle site is clamped-off while using a multi-needle set, the flow rate to the remaining needle site(s) will increase. To compensate for this increase, it is advised to manually decrease the flow rate on the flow dial. Refer to the OneSett Flow Rate Compensation Table in the "Troubleshooting" section on page 15 of this manual. Users should always consult with their provider regarding changes in infusion flow rates.
- Each OneSett is calibrated from 10-60 ml/hr/site for the number of needles included (1-4 configurations). The OneSett enables the selection of flow rates between 10 ml/hr/site up to 60 ml/hr/site. Each needle site can deliver up to 60 ml/hr of 13-17cP 20% immunoglobulin solution. A four-site needle configuration can provide a total flow rate of 240 ml/hr (60 ml/hr/site).
- Always consult and comply with guidance provided by your healthcare provider(s) and the drug manufacturer regarding the location and the number of infusion sites.
- When using multi-needle set configurations, over-infusion may occur to remaining sites if one or more of the needles is blocked.
- Inaccurate medication delivery, infection, and/or site irritation may result from improper needle insertion and maintenance of the infusion site.
- Verify the correct needle length is used according to your healthcare provider's recommendations.
- Ensure that the needle is not bent beyond 90°.
- Remove the needle guard prior to insertion.
- For suspected site reactions, stop the infusion and consult your healthcare provider.
- Dry prime the set before inserting subcutaneous needles (can be primed manually (see page 11, step #5) or with the syringe driver (see page 13)).

# For Intravenous Infusions

**Syringe Driver:** 13.5psi Constant Pressure Insignis™ Syringe Driver

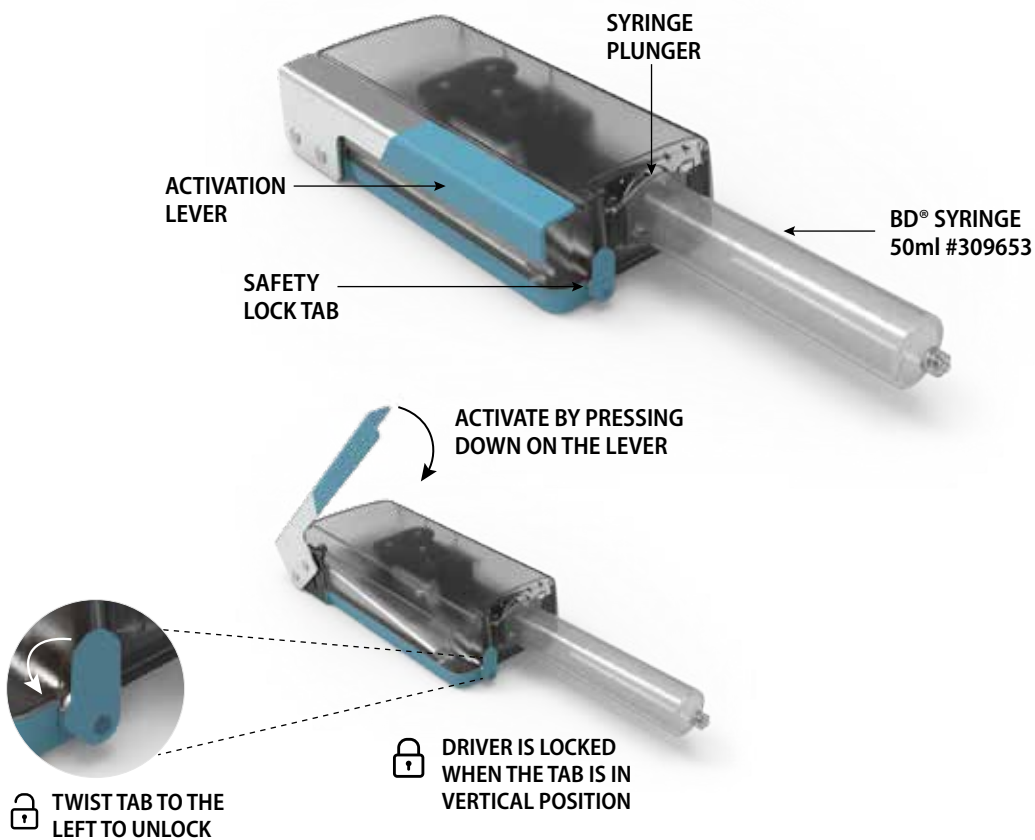

## Intravenous Controller:

The Intravenous (IV) Controller is calibrated for flow rates between 30ml/hr (lowest) to 250ml/hr (highest). There is a KVO feature on the IV Controller for fluids such as normal saline and dextrose.

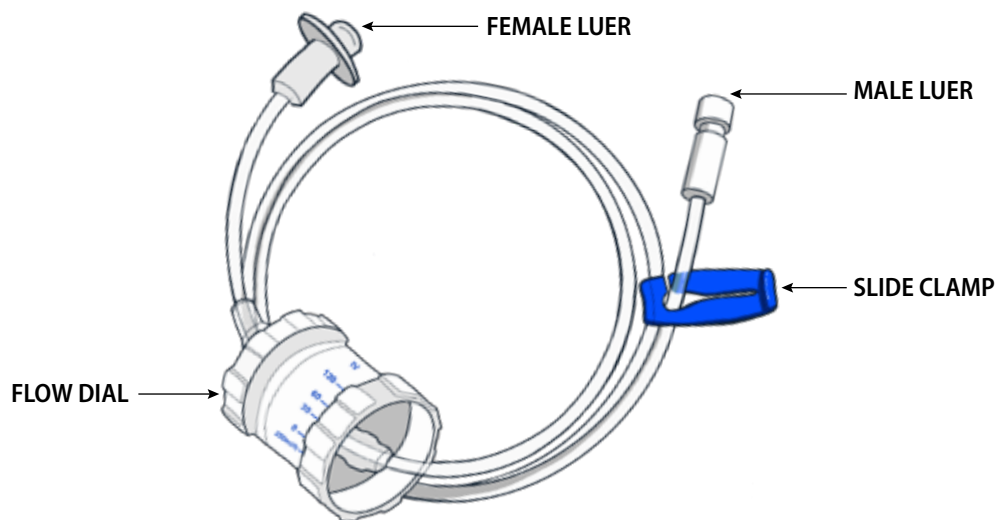

# Intravenous Infusions Using the Intravenous Controller:

## Starting the Infusion for Intravenous Administration using the Intravenous Controller

The IV Controller is calibrated for flow rates between 30ml/hr (lowest) to 250ml/hr (highest). There is a KVO feature on the IV Controller for fluids such as normal saline and dextrose.

1

### Ensure you have all supplies for your infusion.

Verify that you are using the correct administration set for intravenous use for your application per physician's order and have all of the required supplies to perform your infusion.

*Supplies may include any of the following:*

syringe driver and carrying case/pouch, IV Controller set, 50ml BD® syringe (#309653), prefilled syringe(s) of medication with transfer device and/or vials with dispensing pin/mini spike, saline flush for pre and post medication, heparin or other lock solution if ordered, antiseptic wipes, tape or securement device, gauze and/or bandage(s), biohazard disposal container, disposable gloves.



2

### Wash hands

Wash hands thoroughly and if needed, wear disposable gloves. Prepare clean surface for set-up.



3

### Fill Syringe

Make sure the drug is at room temperature and fill the 50ml BD® syringe with the required dose. Refer to the drug manufacturer's package insert for complete filling directions.



4

### Attach IV Controller

Using aseptic technique, remove the end cap on the IV Controller and attach the IV Controller to the syringe by connecting the female luer to the mouth of the syringe.



5

### Prime IV Controller

Set the IV Controller to OPEN (250ml/hr) for priming; gently press on the syringe plunger and prime the administration set until one or two drops of fluid without air are noted; set the dial to 0ml/hr (OFF).



6

### Connect IV Controller to Catheter

Follow healthcare provider instructions for line care. Using aseptic technique, remove cap from the IV Controller and attach to the IV line.

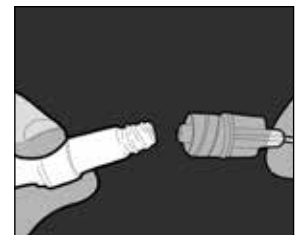

## Intravenous Infusions Using the Intravenous Controller:

# 7

### Load Syringe Driver

Turn the Insignis™ Syringe Driver's safety lock tab to horizontal position (unlocked). Load syringe into the syringe driver, allowing the plunger to move the mechanism back to accommodate the 50ml BD® syringe; rotate the syringe so that the syringe graduations are facing up. Un-clamp the IV line to allow the infusion to proceed.



# 8

### Activate Syringe Driver

Turn the syringe driver's safety lock tab to vertical position (locked). Confirm the IV Controller is set to 0ml/hr (OFF). Press the side lever fully one time for up to 10ml of fluid; for 50ml this is 5 times. Press the lever one additional time to ensure the syringe plunger is fully engaged. The driver will run silently from the beginning of the infusion to the end. Note that you cannot over-engage the syringe driver by activating the lever more than 5 times.

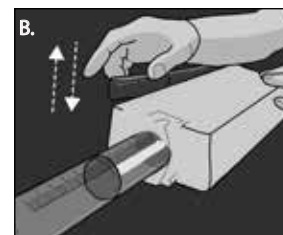

# 9

### Set Flow Rate

Set the flow on the flow dial as prescribed by physician. If advised by the clinician, change or set the flow rate appropriately. Do not use any flow rate without instructions from your provider.



# 10

### Check Progress

Check the infusion progress periodically by ensuring that the syringe plunger is moving, and volume is decreasing. The infusion may require an extra lever activation to ensure a complete infusion.



## Ending the Infusion for Intravenous Administration:

# 1

### Remove Syringe

When the syringe is empty, stop the infusion and clamp the IV line. Turn the safety lock tab to the horizontal position (unlocked) on the syringe driver and rotate the syringe to withdraw from the driver. Remove the infusion set from the IV catheter. Un-clamp the IV line and flush as prescribed by the physician. Clamp IV line or provide care per facility protocol.

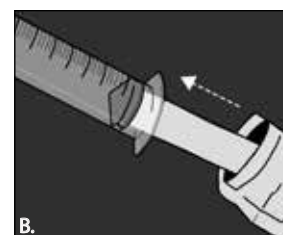

## Intravenous Infusions Using the Intravenous Controller:

### Ending the Infusion for Intravenous Administration *(continued)*:

# 2

#### Catheter Removal

Check the physician's orders for catheter care or removal.



# 3

#### Dispose of Materials

Carefully dispose of materials in a sharps container per local regulations.



## Troubleshooting

### No Flow

- Check to ensure the slide clamps are open.
- Ensure that the syringe driver is engaged according to the syringe driver's instructions for use: Turn the syringe driver's safety lock tab to the vertical position (locked). Press the side lever fully one time for up to 10ml of fluid; for 50ml this is 5 times. Press the lever one additional time to ensure the syringe plunger is fully engaged.
- While preserving the sterility of the male luer disc, disconnect the male luer from the catheter or needle-free adapter and note if fluid drops occur. If there are fluid drops, then the system is operating properly and there is likely an issue with the catheter or needle-free adapter. Refer to the catheter or needle-free adapter manufacturer's instructions for troubleshooting.
- If medication fails to deliver, try replacing the IV Controller, prime again, and determine if the medication has been delivered.
- If medication is coming from the system but not passing through the catheter, contact the healthcare provider for assessment.
- If no flow is experienced after performing the mitigation efforts outlined above, contact your healthcare provider or the device manufacturer.

### Slow Flow

- If slow flow is experienced during the infusion, there may be a partial blockage in the IV Controller, catheter, or the needle free adapter. Disconnect the IV Controller from the catheter to determine if there is a blockage. If there is an appropriate amount of fluid dripping from the IV Controller, contact the catheter or needle-free adapter manufacturer to determine how to proceed.
- Slow flow may occur due to syringe friction. First, remove the syringe from the syringe driver by turning the syringe driver's safety lock tab to the left (this will stop the infusion). Secondly, set the flow dial on the IV Controller to 0 mL/hr and disconnect it from the syringe. Check the syringe friction by pulling back on the syringe plunger and allow air to enter the syringe. With the syringe in a vertical position (upright), purge the air out, noting the level of difficulty required to perform this procedure. If the syringe plunger is difficult to move, this will result in a slower than normal infusion time. A replacement syringe is recommended.
- If any slide clamp has been engaged for a period of time, it may cause a narrowing of the tubing, which could result in slower than normal performance. A replacement administration set is recommended.
- If the needle or catheter is displaced outside the vein, infiltration may have occurred, which may result in a slower flow rate. Check for infiltration or extravasation. Discontinue infusion and contact physician.
- The occurrence of a blood clot could also cause a slow flow rate. If you suspect a blood clot, stop infusion, and immediately contact your provider or your doctor.



## Intravenous Infusions Using the Intravenous Controller:

### Flow Rate Compensation

In a constant pressure infusion system, everything in the fluid path serves to decrease the flow rate. By design, resistance factors such as drug viscosity, catheter tubing resistance, and venous back pressure are compensated for in the Insignis™ Syringe Infusion System to provide the patient with the expected flow rate, as indicated on the flow dial. When tested outside of patient use, the flow rates will appear faster without the above factors included. The table below shows the expected test flow rates when measuring flow rate using distilled water.

Controller Dial Labeled Flow Rate (mL/hr)	Expected (Nominal) Water Flow Rate (mL/hr)
KVO (8 mL/hr)	8
30	32
40	43
50	53
60	65
75	81
100	108
120	130
150	161
180	192
200	213
225	239
240	255
250	265

### Use of the Insignis™ System:

- For normal use and flow rates greater than 30ml/hr, the IV Controller is recommended.
- For longer delivery times, the IV Controller can be set at the lower end of the scale, which may be useful for Keep-Vein-Open (KVO) therapy. The use of Insignis™ Fixed Rate Tubing for slower flow rates is available: 10ml/hr (5 hour delivery) and 50ml/hr (1 hour delivery). Other fixed flow rates are available.

### Testing and Calibration

To test the syringe driver:

1. Fill the 50ml BD® syringe with 10ml of 0.9 NaCl (Sodium Chloride) or distilled water.
2. Connect female luer lock of the IV Controller to the syringe.
3. Set the IV Controller's dial to 250ml/hr (OPEN), purge air, and then set the IV Controller's dial to 0ml/hr (OFF).
4. Load the syringe into the driver; rotate the syringe into place so that the syringe graduations are facing up.
5. Turn syringe driver safety lock tab to the vertical position (locked). Pump lever on side of syringe driver once.
6. Set the IV Controller to 60ml/hr.
7. Measure the time for the fluid to be delivered; this should take between 8 - 11 minutes to confirm normal operation.

Note: the rate used for water is 65ml/hr, see flow compensation in the table above.

# For Use With Subcutaneous Immunoglobulins

Syringe Driver: 13.5psi Constant Pressure Insignis™ Syringe Driver

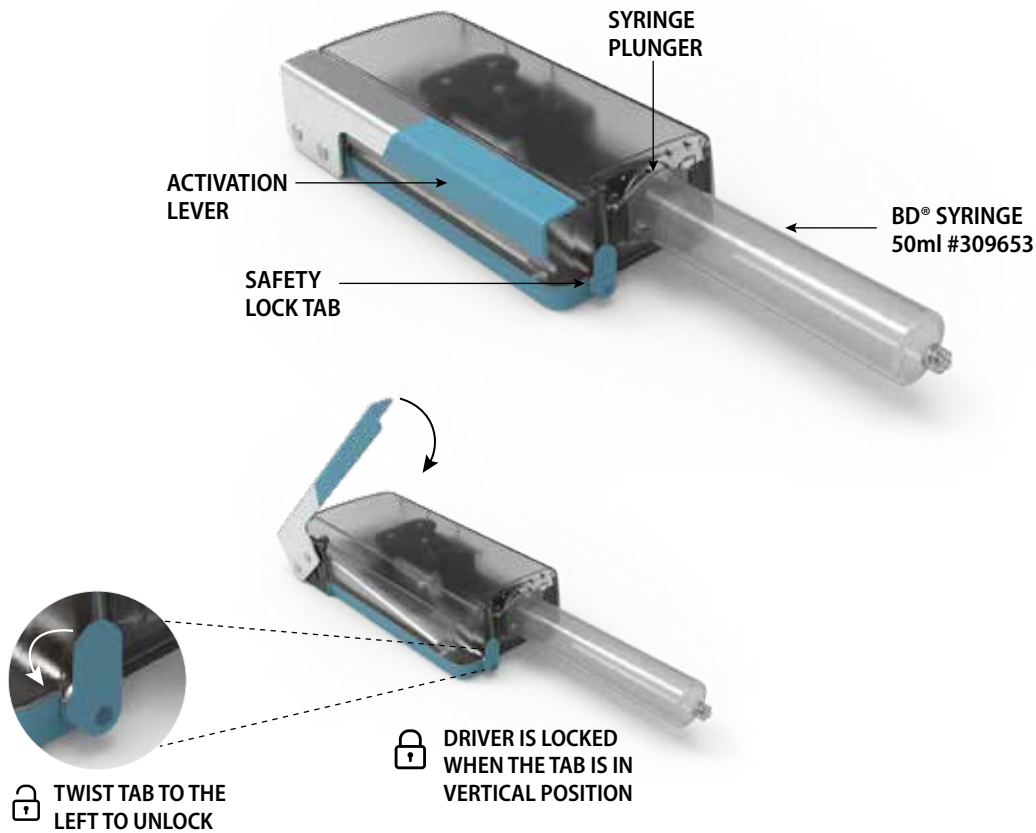

## OneSett™ Subcutaneous Administration Set: *(Selectable Rate Flow Dial and Needle Administration Set - 24" tubing)*

Each OneSett is calibrated from 10-60ml/hr/site for the number of needles required. The OneSett enables the selection of flow rates between 10ml/hr up to 60ml/hr. Each needle site can deliver up to 60ml/hr of 13-17cP 20% immunoglobulin solution. For example: a four-site needle configuration can provide a total flow rate of 240ml/hr (60ml/hr/site).

*Note: The OneSett™ is intended for use with 20% Immune Globulin (Human) Solutions. Always consult the drug manufacturer's package insert for specific drug information.*

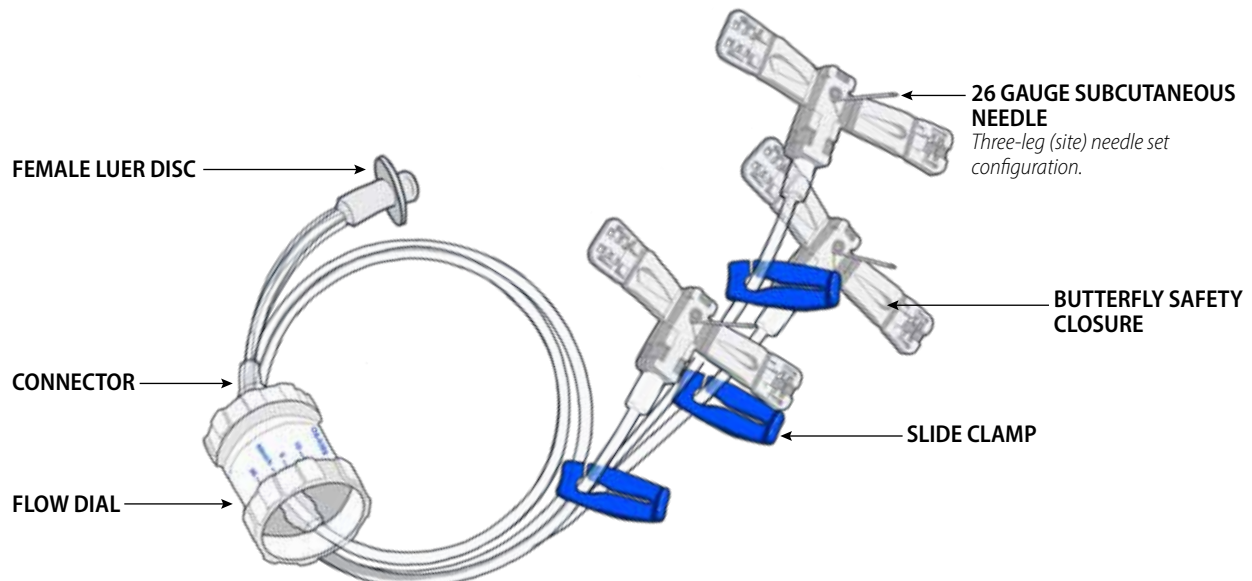

# Subcutaneous Immunoglobulin Infusions Using the OneSet™

## Starting the Infusion for Subcutaneous Administration *using the OneSet™ Subcutaneous Administration Set*

- 1** Verify that you are using the correct administration set, making sure to check the number of sites and needle length on the packaging and that you have all required supplies to perform the infusion.

*Supplies may include any of the following:*

syringe driver and carrying case/pouch, OneSet™, 50ml BD syringe (#309653), prefilled syringe(s) of medication with transfer device and/or vials with dispensing pin/mini spike, antiseptic wipes, tape or securement device, gauze and/or bandaid(s), bio hazard disposal container, disposable gloves.

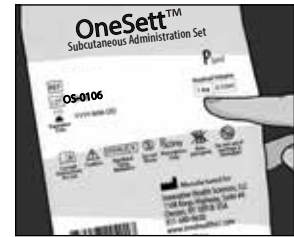

- 2** **Wash hands**

Wash hands thoroughly and if needed, wear disposable gloves. Prepare clean surface for set-up.



- 3** **Fill Syringe**

Make sure the drug product is at room temperature and fill 50ml BD® syringe to required dose. Refer to the drug manufacturer's instructions for complete filling directions.



- 4** **Attach OneSet™**

Using aseptic technique, remove the OneSet™ end cap and attach to 50ml BD® syringe.



- 5** **Prime OneSet™**

Priming Method #1: Set OneSet™ to OPEN (60ml/hr). Gently press on the syringe plunger and prime the set, taking care to stop before medication reaches the needles. Set controller to 0ml/hr (OFF). See page 13 for priming method #2 using the syringe driver.



- 6** **Prep Infusion Site(s)**

Using aseptic technique, prep infusion site(s) as directed by clinician. Remove rubber band from butterfly, fold wings back, and remove needle guard.



# Subcutaneous Immunoglobulin Infusions Using the OneSet™

## 7

### Insert Needle(s)

Insert needle(s) into appropriate locations in subcutaneous tissue at 90° angle. Lay butterfly wings flat on skin. Cover site with tape or adhesive dressing. If checking for blood return, after inserting the needles, pause, gently pull back on the syringe plunger. If blood is noted in the tubing, follow drug manufacturer's recommendations.

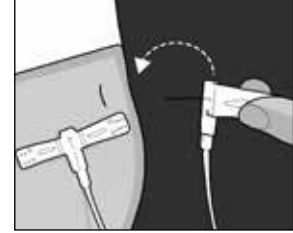

## 8

### Load Syringe Driver

Turn the Insignis™ Syringe Driver's safety lock tab to horizontal position (unlocked). Load syringe into pump, allowing plunger to move pusher back to accommodate 50ml BD® syringe; rotate the syringe so that the syringe graduations are facing up.

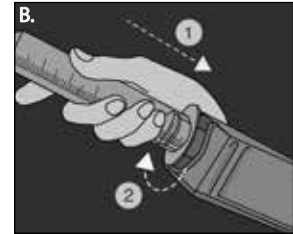

## 9

### Activate Syringe Driver

Turn the syringe driver's safety lock tab to vertical position (locked). Confirm the controller is set to 0ml/hr (OFF). Press the side lever fully one time for up to 10ml of fluid; for 50ml this is 5 times. Press the lever one additional time to ensure the syringe plunger is fully engaged. The driver will run silently from the beginning of the infusion to the end. Note that you cannot over-engage the syringe driver by activating the lever more than 5 times.

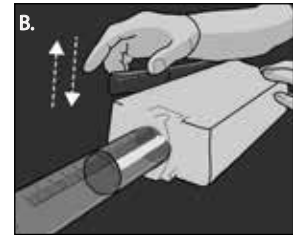

## 10

### Set Flow Rate

As advised by your healthcare provider, set the appropriate flow rate on the flow dial and begin administration. (Do not exceed the maximum flow rate as indicated by your provider, refer to the "Notes for Clinicians" section on page 18 of this manual for device flow rate specifications.)

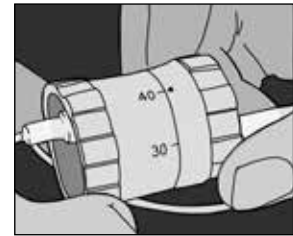

## 11

### Check Progress

Check the infusion progress periodically by ensuring that the syringe plunger is moving, and volume is decreasing. The infusion may require an extra lever activation of the syringe driver lever to ensure a complete infusion.



# Subcutaneous Immunoglobulin Infusions Using the OneSet™

## Method # 2 for Priming the Administration Set Using the Insignis™ Syringe Driver:

*It may be easier for some patients to prime their administration set(s) using the Insignis™ Syringe Driver.*

**1**

### Attach Set to Syringe

Using aseptic technique, connect the administration set to the filled syringe.



**2**

### Set dial the flow dial.

Set the flow dial to 0ml/hr, OFF.

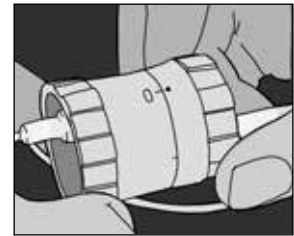

**3**

### Load Syringe Driver

Place the syringe into the syringe driver.



**4**

### Activate Syringe Driver

Activate the syringe driver by pressing down on the lever.

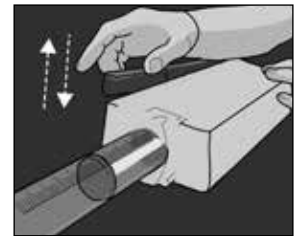

**5**

### Increase Flow Rate

With the administration set tubing in view, slowly increase the flow rate on the flow dial to about 10ml/hr (slow) and carefully monitor the drug filling the tubing.

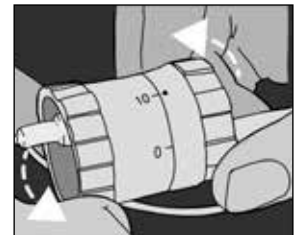

**6**

### Check Progress

Observe the fluid in the tubing and stop the controller by setting it to 0ml/hr (OFF) before the drug reaches the needles (dry-prime).



**7**

### Insert Needles

Insert needles into subcutaneous tissue.

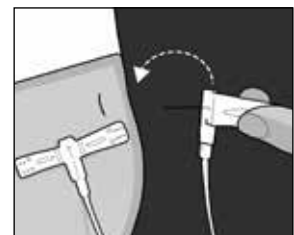

## Subcutaneous Immunoglobulin Infusions Using the OneSet™

# 8

### Set Flow Rate

Set the initial flow rate on the flow dial as indicated by your healthcare provider.

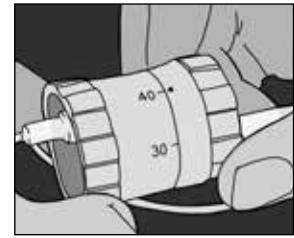

## Ending the Infusion for Subcutaneous Administration:

# 1

### End Infusion

When the syringe is empty, stop the infusion by turning the safety lock tab to the horizontal position (unlocked).

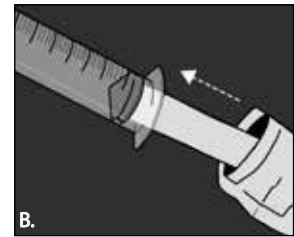
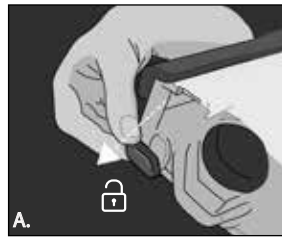

# 2

### Remove Dressing

Pause before removing needles; allow site pressures to decrease naturally. Remove dressing from insertion site(s). To minimize accidental risk of needle stick injury, use one hand to remove needle(s). Using the same hand, squeeze butterfly safety closure wings together to firmly encase needle. This will produce an audible “click” with tactile feedback.

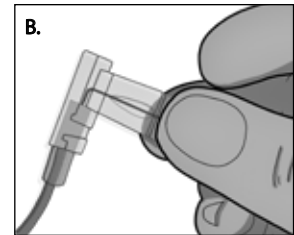
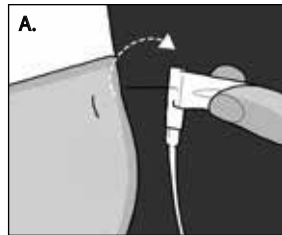

# 3

### Remove Syringe

Remove the syringe from the syringe driver by rotating syringe until tabs are clear and withdraw the syringe.

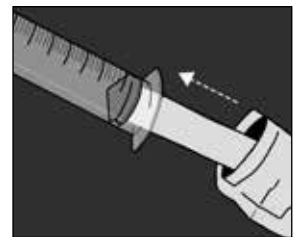

# 4

### Dispose of Materials

Carefully dispose of materials in a sharps container per local regulations.



# Subcutaneous Immunoglobulin Infusions Using the OneSet™

## Troubleshooting

Troubleshooting the Insignis™ Syringe Infusion System is simple for no flow or slow flow.

### No Flow

- Check to ensure the slide clamps are open.
- Ensure that the syringe driver is engaged according to the syringe driver's instructions within this manual: Turn syringe driver safety lock tab to vertical position (locked). Press the side lever fully one time for up to 10ml of fluid; for 50ml this is 5 times. Press the lever one additional time to ensure the syringe plunger is fully engaged.
- Try replacing the OneSet™, prime again, and determine if the medication has been delivered.
- If no flow is still experienced after the troubleshooting efforts outlined above, contact your healthcare provider or the device manufacturer.

### Slow Flow

- The absorption of medication into the patient's tissues may cause slow flow. After a few infusions, the body may create pockets or "depots," which help facilitate the medication's absorption. Therefore, the first few infusions may take longer than anticipated as the depots are not yet formed.
- Assure that the correct needle length is used. The medication may not be reaching below the dermal layer of the skin if the needle is not the optimal length for the patient.
- Slow flow may occur due to syringe friction. First, remove the syringe from the syringe driver by turning the syringe driver's safety lock tab to the left (this will stop the infusion). Secondly, set the flow dial on the OneSet™ to 0 mL/hr and disconnect it from the syringe. Check the syringe friction by pulling back on the syringe plunger and allow air to enter the syringe. With the syringe in a vertical position (locked), purge the air out, noting the level of difficulty required to perform this procedure. If the syringe plunger is difficult to move, this will result in a slower than normal infusion time. A replacement syringe is recommended.
- A larger diameter needle is not needed to achieve a faster flow rate as the Insignis-26G™ needle delivers the maximum flow rates as recommended in the drug package insert.

### Site Reactions

Should you experience pain during the infusion, pause the infusion\* and consult your health care provider for instructions on how to minimize the possibility of site reactions. With the correct guidance, site reactions can be successfully avoided and/or reduced.

Site complications have many causes and vary depending on the patient's level of experience with infusion therapy. Pain, redness, blanching, itching, and leaking are side effects that may be caused by:

- Inappropriate needle length
- Flow rate is too fast
- Volume is too much per infusion site
- Site location
- Failure to use dry needle insertion, not allowing alcohol to dry, or angle of needle insertion.

\*For patients who benefit from pausing the dose, the Insignis™ Syringe Driver has the ability to deliver up to 10ml for each full stroke of the lever. This pause can give patients the ability to review the status of the infusion before proceeding with the next dose.

### Flow Rate Compensation Table for the OneSet™ Subcutaneous Administration Set

If a needle is clamped-off while using a multi-needle set, the flow rate to the remaining needle site(s) will increase. To compensate for this increase, the user may manually decrease the flow rate on the flow dial. See table below for recommendations. Users should always consult with their provider regarding changes in infusion flow rates.

Number of Needles	Decrease by	Multiply by
2	50%	50%
3	30%	70%
4	25%	75%

The example below using the OneSet™ demonstrates the calculation used to compensate for one clamped-off needle while using a four-needle site configuration.

METHOD      CALCULATION  
Decrease by:    50ml/hr x 25% (.25) = 12.5 ; 50ml/hr – 12.5 = 37.5ml/hr  
Multiply by:    50ml/hr x 75% (.75) = 37.5ml/hr  
FLOW RATE:    Set the new flow rate to 37.5ml/hr

## Instructions for Use

### Care and Maintenance of the Syringe Driver

Clean the syringe driver after every use with a lint-free cloth and an alcohol-free cleaning agent.

For a thorough clean follow the procedure below:

- Using rubber gloves, prepare a solution of one part sodium hypochlorite (bleach) and one part tap water.
- Using a clean lint-free cloth, wipe the device with the prepared solution. Additional wipes may be used as needed.
- Using a clean lint-free cloth dampened with deionized water (RO/DI water), wipe the device.
- Using a new clean lint-free cloth, dry the device.

Perform the visual inspection as follows:

- Inspect the syringe driver under adequate lighting conditions to determine if all visible substances and debris have been removed from the device.
- Do not clean any part of the syringe driver that is not easily accessible (i.e. internal working mechanisms). Do not use the driver if it has been internally exposed to or immersed in fluid.
- Note: The use of alcohol is not recommended to clean the plastic as it may harm the cover materials.
- Since the Insignis Syringe Infusion System may be used in many different environments and exposed to any different elements, care should be exercised to prevent foreign materials, debris, fluids, and other contaminants from entering the mechanism of the driver.
- The Insignis Syringe Infusion System is designed to work as a complete system. Flow control is determined by the flow control device, not the syringe driver. Insignis products do not require any calibration or testing on the part of the user or the provider.
- Under normal operation, the expected life-cycle of the Insignis™ Syringe Driver is approximately 3,000 uses.

### Storage & Use

- The syringe driver, IV Controller, OneSett™ Subcutaneous Administration Set, are recommended for storage in a dry place (humidity levels 15% - 90%) at room temperature (61-86°F; 16-30°C).
- The syringe driver, IV Controller, and OneSett Subcutaneous Administration Set are recommended for use up to or less than 10,000 feet or 4,267 meters altitude.

Disposal of Syringe Driver

- Once the syringe driver has reached its use life, dispose of it in accordance with local regulations. Note that the syringe driver is not a biohazard as it is intended for multiple infusions throughout its lifecycle.

### Checking Infusion Progress

To check the infusion's progress, observe the time the infusion began and verify the movement of the syringe plunger. The rate of the infusion should match the rate that appears on the flow control device multiplied by the number of infusion sites. See the "Flow Rate vs. Time Chart" on page 20 to determine the time and flow rate based on infusion volume.

### Stopping the Infusion

In the event it is necessary to stop the infusion prior to completion and remove a full or partially full syringe, turn the syringe driver's safety lock tab to the horizontal position (unlocked), to release the syringe. The mechanism will quickly move rearward and the syringe wings are now released, enabling it to be rotated counter clockwise and removed from the syringe driver.



## Notes for Clinicians and Users

The following sections contain the flow rate performance information for the Insignis Syringe Infusion System. The flow rate performance of Insignis Syringe Infusion System may vary from the stated values if not used within the stated operating conditions. Under clinical use, infusion factors such as ambient and fluid temperature, atmospheric pressure, patient factors, and fluid viscosity may compound with the flow rate performance of the Insignis Syringe Infusion System devices and may affect the delivered flow rate. The Insignis Syringe Infusion System's intended operating conditions are 68 – 77°F (20 – 25°C) and a head height of 8 inches. The flow rate may vary up to  $\pm 4.8\%$  when used up to  $\pm 24$  inches (up to  $\pm 2.4\%$  per foot). The flow rate may vary up to  $\pm 3\%$  mL/hr per degree Celsius. Flow rate performance was tested up to 10,000 feet altitude with minimal effects on flow rate. These factors should be considered when performing an infusion.

The flow rates state the minimum and maximum flow rate.

### Intravenous Infusion

The table below presents the measured and expected flow rate performances for the Intravenous Controller when used in the intended operating conditions.

Controller Dial Labeled Flow Rate (mL/hr)	Expected Clinical Flow Rate Performance (mL/hr)	Bench Test Flow Rate Performance (mL/hr)
KVO*	3 - 13	3 - 13
30	22 - 38	24 - 40
40	32 - 48	35 - 51
50	42 - 58	45 - 61
60	51 - 69	56 - 74
75	66 - 84	72 - 90
100	91 - 109	99 - 117
120	110 - 130	120 - 140
150	140 - 160	151 - 171
180	170 - 190	182 - 202
200	188 - 212	201 - 225
225	212 - 238	226 - 252
240	227 - 253	242 - 268
250	236 - 264	251 - 279

\* KVO (8ml/hr) is only recommended for medications such as saline and dextrose.

\*\* See Flow Rate Compensation section on page 9.

## Notes for Clinicians and Users

### Subcutaneous IgG Infusion

**OneSett Subcutaneous Administration Set:** The OneSett is an all-in-one pre-packaged administration set with the tubing, flow dial, and 26G subcutaneous needle set(s) attached as a single device, therefore there is no need to mix and match tubings and needles to achieve specific flow rates. Based on the site volumes and the patient's physical parameters, clinicians may determine the number of sites and needle length required. The flow rate per infusion site is selected directly on the dial per the drug manufacturer's instructions and the provider's recommendations. The OneSett is calibrated for 20% IgG medications and available in 1 – 4 needle set configurations.

#### Using the OneSett:

- Each OneSett is calibrated from 10-60ml/hr/site for the number of needles included. The OneSett enables the selection of flow rates between 10ml/hr/site up to 60ml/hr/site. Each needle site can deliver up to 60ml/hr of 13-17cP 20% immunoglobulin solution. A four-site needle configuration can provide a maximum total flow rate of 240ml/hr (60ml/hr/site).
- If a needle site is clamped-off while using a multi-needle administration set, the flow rate to the remaining needle site(s) will increase. To compensate for this increase, it is advised to manually decrease the flow rate on the flow dial. Refer to the flow rate compensation table on page 15 for recommendations.

### Flow rate performance data for the Insignis system when used with Hizentra®, Cuvitru®, and Xembify®

#### Hizentra® for Primary Immunodeficiency (PI) Flow Rates

The table below presents the expected flow rate performances per infusion site for the OneSett™ Subcutaneous Administration Set when used with Hizentra® for Primary Immunodeficiency (PI) in the intended operating conditions. Throughout the infusion, the measured flow rate may vary from the flow rate labeled on the dial. Do not exceed the prescribed flow rate.

OneSett™ Subcutaneous Administration Set	Dial Setting - Nominal Flow Rate per Infusion Site (mL/hr/site)			
	10	15*	20*	25 – 60
1 Needle	6.8 - 14	12.2 – 18.9	16.9 - 24.6	Flow rate tolerances may exceed maximum drug flow rate.
2 Needles	7.6 - 13.2	12.3 – 18.8	17.7 - 23.8	
3 Needles	8.5 - 12.3	13.2 - 17.9	18.3 - 23.2	
4 Needles	8.5 - 12.3	13.3 - 17.9	18.5 - 23	

\*Subsequent infusion after initial infusion.

Outside of drug's prescribing information recommended minimum - maximum flow rate.

#### Hizentra® for Chronic Inflammatory Demyelinating Polyneuropathy (CIDP) Flow Rates

The table below presents the expected flow rate performance per infusion site for the OneSett™ Subcutaneous Administration Set when used with Hizentra® for Chronic Inflammatory Demyelinating Polyneuropathy (CIDP) in the intended operating conditions. Throughout the infusion, the flow rate may vary from the flow rate labeled on the dial. Do not exceed the prescribed flow rate.

OneSett™ Subcutaneous Administration Set	Dial Setting - Nominal Flow Rate per Infusion Site (mL/hr/site)							
	10	15	20*	25*	30*	35*	40*	45 - 60
1 Needle	6.8 - 14	12.2 - 18.9	16.9 - 24.6	21.4 – 30.5	25.7 - 36.6	30 – 42.6	34.2 - 48.8	Flow rate tolerances may exceed maximum drug flow rate.
2 Needles	7.6 - 13.2	12.3 - 18.8	17.7 - 23.8	22.3 – 29.6	26.9 - 35.4	31.7 - 40.9	36.6 - 46.4	
3 Needles	8.5 - 12.3	13.2 – 17.9	18.3 - 23.2	22.9 - 29	27.5 - 34.8	32.1 - 40.5	36.6 - 46.4	
4 Needles	8.5 - 12.3	13.3 - 17.9	18.5 - 23	23.2 – 28.8	27.8 - 34.5	32.4 - 40.2	37 - 46	

\*Subsequent infusion after initial infusion.

Outside of drug's prescribing information recommended minimum - maximum flow rate.

## Notes for Clinicians and Users

### Subcutaneous IgG Infusion

#### Xembify® for Primary Immunodeficiency (PI) Flow Rates

The table below presents the expected flow rate performance per infusion site for the OneSett™ Subcutaneous Administration Set when used with Xembify® for Primary Immunodeficiency (PI) in the intended operating conditions. Throughout the infusion, the flow rate may vary from the flow rate labeled on the dial. Do not exceed the prescribed flow rate.

OneSett™ Subcutaneous Administration Set	Dial Setting - Nominal Flow Rate per Infusion Site (mL/hr/site)				
	10	15	20	25	30 - 60
1 Needle	6.1 – 10.5	9.8 – 15.1	13.6 – 19.7	17.2 - 24.4	Flow rate tolerances may exceed maximum drug flow rate.
2 Needles	6.1 – 10.6	9.9 - 15.1	14.2 - 19.1	17.9 - 23.7	
3 Needles	6.8 – 9.9	10.6 - 14.4	14.7 - 18.6	18.4 - 23.2	
4 Needles	6.8 – 9.9	10.7 – 14.3	14.8 - 18.4	18.6 - 23	

\*Subsequent infusion after initial infusion.

Outside of drug's prescribing information recommended minimum - maximum flow rate.

#### Cuvitru® for Primary Immunodeficiency (PI) Flow Rates

The table below presents the expected flow rate performance for the OneSett™ Subcutaneous Administration Set when used with Cuvitru® for Primary Immunodeficiency (PI) in the intended operating conditions. Throughout the infusion, the flow rate may vary from the flow rate labeled on the dial. Do not exceed the prescribed flow rate.

OneSett™ Subcutaneous Administration Set	Dial Setting - Nominal Flow Rate per Infusion Site(mL/hr/site)									
	10	15	20*	25*	30*	35*	40*	45*	50*	60*
1 Needle	Flow rate tolerances may result in flow rates below 10 ml/hr/site.	11.4 – 17.8	15.2 - 22.2	19.7 - 28.1	23.4 - 32.8	27.4 - 39	30.7 - 43.9	35.5 - 49.5	39.9 - 53.5	45.3 – 58.5
2 Needles		11.6 - 17.6	16 – 21.5	20.5 – 27.3	24.2 – 32	29 – 37.4	32.9 – 41.8	37.5 - 47.5	41.2 – 52.2	46.3 - 57.6
3 Needles		12.4 – 16.8	16.5 - 21	21.1 - 26.7	24.8 – 31.4	29.3 – 37.1	32.9 – 41.8	37.5 - 47.5	41.2 - 52.2	46.8 – 57.1
4 Needles		12.5 – 16.7	16.7 – 20.8	21.3 – 26.5	25 - 31.2	29.6 – 36.8	33.3 – 41.4	37.9 – 47.1	42.1 – 51.3	46.3 - 57.6

\*Subsequent infusion after initial infusion.

Outside of drug's prescribing information recommended minimum - maximum flow rate.

## Flow Rate vs. Time Chart

This chart is used to determine the relationship between volume, time, and flow rate during an infusion.

*Note: The table below shows the expected infusion times for delivered flow rates at specific volumes.*

*These times may vary based on the infusion parameters (i.e. temperature, viscosity, patency). Refer to the drug manufacturer's package insert for minimum and maximum flow rate guidelines.*

		Infusion Time (hhmmss)								
Flowrate (mL/hr/site)		1.0	2.5	10	20	60	100	150	200	250
Volume (mL)	1	1:00:00	0:24:00	0:06:00	0:03:00	0:01:00	0:00:36	0:00:24	0:00:18	0:00:14
	5	5:00:00	2:00:00	0:30:00	0:15:00	0:05:00	0:03:00	0:02:00	0:01:30	0:01:12
	10	10:00:00	4:00:00	1:00:00	0:30:00	0:10:00	0:06:00	0:04:00	0:03:00	0:02:24
	15	15:00:00	6:00:00	1:30:00	0:45:00	0:15:00	0:09:00	0:06:00	0:04:30	0:03:36
	20	20:00:00	8:00:00	2:00:00	1:00:00	0:20:00	0:12:00	0:08:00	0:06:00	0:04:48
	25	25:00:00	10:00:00	2:30:00	1:15:00	0:25:00	0:15:00	0:10:00	0:07:30	0:06:00
	30	30:00:00	12:00:00	3:00:00	1:30:00	0:30:00	0:18:00	0:12:00	0:09:00	0:07:12
	35	35:00:00	14:00:00	3:30:00	1:45:00	0:35:00	0:21:00	0:14:00	0:10:30	0:08:24
	40	40:00:00	16:00:00	4:00:00	2:00:00	0:40:00	0:24:00	0:16:00	0:12:00	0:09:36
	45	45:00:00	18:00:00	4:30:00	2:15:00	0:45:00	0:27:00	0:18:00	0:13:30	0:10:48
	50	50:00:00	20:00:00	5:00:00	2:30:00	0:50:00	0:30:00	0:20:00	0:15:00	0:12:00
	55	55:00:00	22:00:00	5:30:00	2:45:00	0:55:00	0:33:00	0:22:00	0:16:30	0:13:12
60	60:00:00	24:00:00	6:00:00	3:00:00	1:00:00	0:36:00	0:24:00	0:18:00	0:14:24	

## Insignis Syringe Infusion System Flow Profile

The graph below presents a measured flow profile for the Insignis Syringe Infusion System. The flow profile for any flow rate available in the Insignis system is expected to demonstrate a similar flow profile.

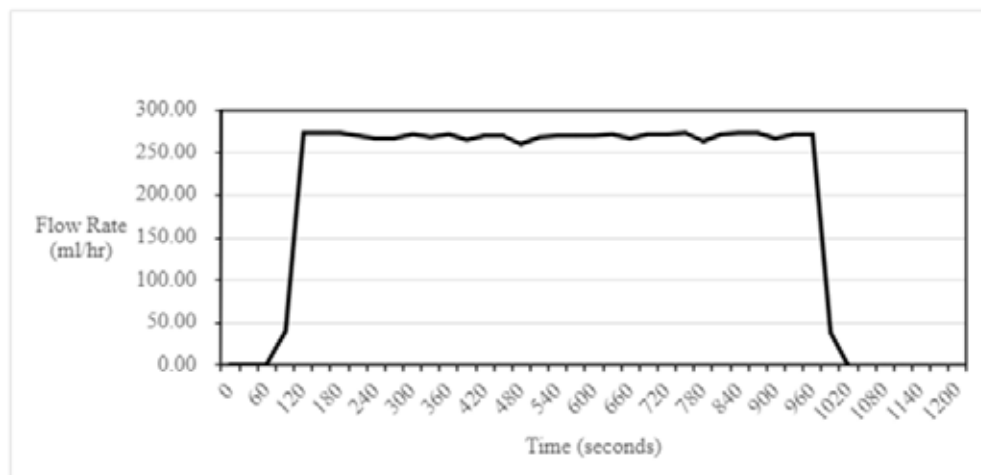

## Insignis™ Technical Information

### System

Reservoir volume: 50ml  
 Accuracy: See "Notes for Clinicians and Users" on page 17.  
 Altitude: Flow rate was tested up to 10,000-feet altitude with minimal effects on flow rate.  
 Temperature Sensitivity: The flow rate may vary up to  $\pm 3\%$  mL/hr per degree Celsius.  
 Operating Pressure: 13.5psi Nominal  
 14.2psi Max

Accuracy Table – OneSett™ with Insignis™ Syringe Driver – see "Notes for Clinicians" section on page 18.

### Syringe Driver

Weight: 1.3lb  
 Length: 8.5in  
 Width: 4.0in  
 Height: 2.5in

### Intravenous Controller

Length: 60in  
 Accuracy: See "Notes for Clinicians and Users" section on page 17.  
 Residual volume: 0.35 ml

### OneSett™ Subcutaneous Administration Set

Length: 32 - 40in  
 Residual volume:

1 site	0.78 ml
2 sites	1.39 ml
3 sites	1.90 ml
4 sites	2.43 ml

*Note: Product lengths are approximate.*

### Insignis™ Product Identifiers

#### INSIGNIS SYRINGE DRIVER

Part #  
 D10021



#### SYRINGE DRIVER CARRYING CASE (Included with Syringe Driver)



#### INTRAVENOUS CONTROLLER (box of 10)

Part #  
 C10031



#### ONESETT™ SUBCUTANEOUS ADMINISTRATION SET (box of 10)

##### Single Needle Set

Length	Part #
6mm	OS-0106
9mm	OS-0109
12mm	OS-0112
14mm	OS-0114



##### Two-Needle Set

Length	Part #
6mm	OS-0206
9mm	OS-0209
12mm	OS-0212
14mm	OS-0214



##### Three-Needle Set

Length	Part #
6mm	OS-0306
9mm	OS-0309
12mm	OS-0312
14mm	OS-0314



##### Four-Needle Set

Length	Part #
6mm	OS-0406
9mm	OS-0409
12mm	OS-0412
14mm	OS-0414



### Syringe for Use with the Insignis™ Syringe Infusion System

Becton Dickinson and Company BD® Luer-Lok 50ml (Sold Separately- Contact your provider)  
 US Reference: 309653; EU Reference: 300865

## Warranty Information

Limited Warranty: Innovative Health Sciences LLC ("Manufacturer") guarantees the Insignis™ Syringe Infusion System free from defects in performance under normal use. This warranty is limited to the Original Purchaser and is valid for a period of three (3) years from purchase date. This warranty does not cover for damage caused by the use of non-proprietary ancillary products. The Manufacturer agrees to repair or replace the Insignis™ Syringe Driver or any ancillary product associated with the Insignis product line, provided that the device is received by the Manufacturer within the three-year time period from date of purchase. Replacement parts and/or complete devices are warranted for the remaining portion of purchase date by the Original Purchaser.

Innovative Health Sciences LLC abides by the quality policies as described in ISO 13485 and CFR 820 so as to confirm and document the product's extensive and rigorous testing procedures. The Insignis™ warranty does not cover third-party products or third-party products used in conjunction with any or all Insignis products.

**Performance Procedure:** All warranty submissions must be submitted in writing via electronic mail (info@innohealthsci.com) or U.S. Postal Service to:

IHS Customer Support and Service  
Innovative Health Sciences LLC  
1108 Kings Highway, Suite #4 Chester, N.Y. 10918 USA

A detailed description of the defect is required in order to commence the reporting. The device of concern must be packaged and returned to the Manufacturer; any loss or damage experienced during shipment is incurred by the Original Purchaser.

This warranty and the associated rights and obligations shall be governed by the laws of the State of New York, USA.

## Definition of Symbols

	Caution		Quantity		Do not reuse
	Consult Instructions for Use		Serial number		Catalog number
	Use by YYYY--MM-DD		Prescription only		Batch code
	Manufacturer		Sterilized using radiation		Volume
	Temperature		Humidity		Altitude
	Pressure device		Non-pyrogenic		Do not insert fingers into device
	Pinch point		European Authorized Representative		Do not use if package is damaged
	Do not use in MRI setting		Do Not Resterilize		Medical Device
	Unique Device Identifier		European Conformity		Date of Manufacture

## References:

<sup>1</sup> The Insignis™ Syringe Infusion System's ability to respond to resistance at the infusion site by automatically decreasing the flow rate can be explained by the Hagen-Poiseuille law, which states that the flow rate is directly proportional to the differential pressure (the pressure difference between the syringe driver (13.5psi) and the patient's infusion site). Thus, during the course of an infusion, as the patient's tissues become increasingly saturated with medication, the pressure at the site also increases. As the infusion system uses a constant force mechanism of 13.5psi, the pressure differential decreases, slowing down the flow rate as a natural and immediate response. Dynamic equilibrium works to sense site irritation and the selectable rate flow control ability enables the patient to decrease the flow rate in real-time to help eliminate site reaction occurrence.

Baker, Mark Paul, Bullock, M., Sealfon A. *A Novel Approach to Customizing the Flow Profile for the Administration of Subcutaneous Immunoglobulins for Individual Infusions with Benefits to Minimize or Eliminate Site Reactions— CASE STUDY.* International Primary Immunodeficiencies Congress; April 2022; Vilamoura, Portugal.



European Authorized Representative

© 2024 Innovative Health Sciences LLC. All Rights Reserved.

MedEnvoy Global B.V.  
Prinses Magrietplantsoen- Suite 123  
2595 AM The Hague  
The Netherlands



INNOVATIVE HEALTH SCIENCES LLC

1108 Kings Highway, Suite #4 Chester, NY 10918 USA  
+1-855-680-0630 | www.innohealthsci.com

04-1036v2