



CRONO S-PID 50



CE
0476

USER GUIDE

Ambulatory infusion pump

**US Federal law restricts this device for sale by
or on order of a physician.**



CANÈ S.p.A. Medical Technology
Via Cuorgnè 42/a 10098 Rivoli (TO) Italy
Tel.+39 011 9574872 - Fax +39 011 9598880
www.canespa.it - mailbox@canespa.it

Manual code: MAN 01/USA/07 S-PID 50
Date of publication: 11/18

INDEX

SECTION 1

Symbols and conventions.....	page 7
CAUTION	page 7
Introduction.....	page 8

SECTION 2

Intended use.....	page 10
WARNING	page 10

SECTION 3

Infusion system.....	page 12
Description of the pump.....	page 12
Technical characteristics.....	page 13

SECTION 4

Factory settings	page 15
Information.....	page 15

SECTION 5

Equipment	page 16
Optional accessories available on request.....	page 17
How to use the accessories provided.....	page 20

SECTION 6

Identifying the device components	page 21
Liquid crystal display	page 22
Examples of indications appearing on the display	page 23
Keypad	page 25

SECTION 7

Reservoir	page 26
Luer Lock cap	page 27
Filtrajet.....	page 28
Y-set	page 28

INDEX

Infusion set	page 29
Identifying the infusion set components	page 29
Preparing for the infusion	page 29
Preparing the reservoir	page 30
Attaching the reservoir to the device	page 31
 SECTION 8	
Keypad lock	page 34
Warning	page 34
 SECTION 9	
Initialization of the pump	page 35
 SECTION 10	
Setting and inserting the battery	page 36
Setting in the OFF condition	page 37
Flow chart of settings in the OFF conditions	page 38
Infusion end acoustic signal	page 39
Setting the number of infusion points	page 39
Setting the partial volume	page 41
Settings in the ON condition	page 43
Setting the infusion duration	page 43
Flow rate setting	page 44
 SECTION 11	
Switching on the pump in time mode	page 45
Switching on the pump in flow rate mode	page 46
Pump in operation	page 47
Infusion set refilling (Prime)	page 47
Withdrawal	page 49
Pushing unit movement	page 49
Occlusion	page 51
Post-Occlusion Bolus	page 51

Infusion end	page 52
Switching off	page 53
Infusion number display	page 53
Saving of set data	page 53

SECTION 12

Battery low warning	page 54
Replacing the battery	page 55
BATTERY CARE	page 57

SECTION 13

GENERAL WARNINGS	page 58
Manual updates	page 58

SECTION 14

Maintenance	page 59
Cleaning and disinfection	page 59
GENERAL WARNINGS	page 60
Storage	page 60
Disposal	page 60
Expected life of the pump	page 60

SECTION 15

Customer Support	page 61
Warranty regulations	page 61

SECTION 16

Signaling errors	page 63
Customer Support Service	page 64

SECTION 17

Instructions in short	page 65
-----------------------------	---------

SECTION 18

Symbols on the pump.....	page 69
Symbols on the syringe blister package.....	page 70

ATTACHMENTS

Attachment 1	page 71
Attachment 2	page 73
Attachment 3	page 74
Attachment 4	page 75
Attachment 5	page 78
Attachment 6	page 79
Attachment 7	page 80

SYMBOLS AND CONVENTIONS

To make consulting this manual easier the following symbols and conventions have been adopted:

Triangle with an exclamation mark

This “Warning” icon signals information that must always be considered to use the pump safely.

**Note pad**

This icon indicates “Notes”, additional information or useful suggestions to use the pump.



The **OFF** condition or pump in the **OFF** position means the pump is switched off and not delivering.

The **ON** condition or pump in the **ON** position means the pump is switched on and is operating/delivering.

CAUTION

US Federal law restricts this device for sale by or on order of a physician.

Thank you for choosing the **CRONO S-PID 50** ambulatory infusion pump.

This manual was written to ensure the optimal use of the pump.

The instructions contained in this manual only concern the **CRONO S-PID 50** ambulatory infusion pump and are addressed to the medical and paramedical personnel who must initially apply the pump and subsequently to patients.

The pump is fitted with a keypad lock system (see page 35) that prevents any change to the programmed parameters. The information concerning the keypad lock/unlock procedure is provided at the end of this manual on a plasticized card.

The purpose of the keypad lock is to prevent accidental or unauthorized changes to the selected parameters; in cases in which it is appropriate for the patient not to know this procedure, the doctor and/or the assistant is advised not to provide the patient with this information.

The instructions contained in this manual are fundamental for safe, correct use of the pump.

Users are advised to read the entire manual before using the device and keep it for future reference.

The pump does not require any installation, testing and/or commissioning.

CANÈ S.p.A. reserves the right to modify the hardware and software specifications described in this manual at any time and without warning.

NOTES

CANÈ S.p.A. reserves the right to modify and/or update this manual at any time and without warning.

With the purpose of making this manual complete and precise, please notify us of any errors or omissions at the following email address: service@canespa.it.

SECTION 2

INTENDED USE

The **CRONO S-PID 50** ambulatory infusion pump has been designed exclusively for subcutaneous immunoglobulin infusions.

Administration of medication with other methods and therapies shall exempt CANÈ S.p.A. from any responsibility.

NOTE



The manufacturer undertakes responsibility in association with the safety and operation of the device, provided that it is used in compliance with these instructions and that any repairs and/or changes have been performed exclusively by the same manufacturer.

WARNING



Improper programming and/or the incomplete understanding of operating functions and alarms may cause death or serious injuries to the patient.

Before using the pump assess its suitability for the type of use and the patient by carefully considering the following aspects:

- the technical specifications of the pump;
- the infusion sets that will be used;
- any use of multiple infusion sets and clamps along the infusion line;
- the type of therapy in the treatment of primitive immunodeficiency, which the patient is undergoing;
- the psychophysical and cognitive conditions of the patient.

The list above is not exhaustive and is provided for purposes of example only, with regard to the clinical procedural aspects, the responsibility of which is borne by the medical or paramedical personnel.

The device must be used:

- under strict medical control,
- adopting suitable procedures and adequate measures towards those patients who may suffer serious consequences (injury or death) following involuntary operations and/or breakdowns with the consequent interruption in the administration of the medication.

Do not prime the infusion line when connected to the patient since this may cause a medication overdose.

Before starting an infusion, inspect the route of the fluid to make sure that there are no folds, clamps or other occlusions upstream; remove any air bubbles.

After inserting the needle check, by means of suction, that it has not been introduced into a vein or in a capillary (for further details on the procedure to use, please refer to your family doctor).

The accuracy and the amount of time necessary to signal an occlusion may vary from the values indicated in this manual, depending on the type of catheter, the infusion set and all the elements in the infusion line.

In case of suspected damage to the pump for any reason (for example due to infiltration of liquid or bangs), contact the Customer Support Service to ascertain the correct operation of the pump. Do not use the pump if damaged.

For doubts concerning the operation of the pump and/or in case of anomalies, interrupt the use of the device and contact the technical assistance service.

Any trace of liquid on the outer part of the pump must be immediately removed with paper towels.

It is important to arrange a procedure and/or system as an alternative to that of the infusion through a pump in case this breaks. A valid solution may be to arrange both a second pump and an alternative system to it.

It is worthwhile that the people who assist and/or live with the user of the pump know how the pump works and the information contained in the instruction manual.

It is important to interrupt the use of the device after its forecast service life following the instructions for its correct disposal.

SECTION 3

INFUSION SYSTEM

For a better absorption of the medication the pump administers 20 µl doses at intervals that depend on the set flow rate. The time interval between doses decreases proportionally as the programmed flow rate increases or the time decreases.

DESCRIPTION OF THE PUMP

The **CRONO S-PID 50** is an ambulatory syringe infusion pump intended for the controlled subcutaneous administration of medication.

The **CRONO S-PID 50** uses specific 50 ml syringes called reservoirs.

The **CRONO S-PID 50** is a product of advanced technology and innovative design. Its reduced size and light weight make it ideal for home use with consequent freedom for the patient to perform daily tasks and enjoy recreational activities during the infusion.

The main features of the pump are:

- the possibility of selecting the time or flow rate programming mode;
- the possibility of fractionating the volume of the medication contained in the syringe in more than one infusion site (in flow rate mode).

The precision of the progression mechanism, which acts directly on the piston of the syringe, allows the pump to administer the medication accurately.

The **CRONO S-PID 50** is equipped with a liquid crystal display showing the doctor and patient useful information concerning the pump's programming, operation and diagnostics.

TECHNICAL CHARACTERISTICS

Size	84.5 x 55 x 42 mm.
Weight	140 g (battery included).
Battery	CR 123A 3V Lithium (approx. 3/6 months battery life - 60/80 infusions).
Reservoir	Specific with a 50 ml capacity and a "luer-lock" universal safety attachment.
Administration volumes	Selectable from 5 to 50 ml at 1 ml stages.
Time mode (Infusion duration)	Selectable from 1 to 50 h with 15' stages.
Flow rate mode	Programmable from 1 ml/h to 50 ml/h at 1 ml/h stages.
Setting the number of infusion sites (only in flow rate mode)	Selectable from 1 to 5 sites.
Flow rate accuracy	+/-3%.
Occlusion pressure	3 bars +/-1.5.
Occlusion signaling time	See ATTACHMENT 2.
Post-occlusion bolus	About 2.1 ml.
Electronic circuit	Managed by a microcontroller with dedicated software.
Data storage	The values selected are automatically stored in a memory that saves them even when the battery is removed.
Display	Liquid crystal.

SECTION 3

Motor	Coreless direct current motor. The microcontroller manages the rotation through an infrared encoder.
Keypad lock	Two levels can be set.
Safety circuits	They control the correct operation by intervening in case of faults with acoustic signals and messages on the display.
Buzzer sound pressure level	52.3 dBA, 54.5 dBA continuous
Operating Conditions	+5°C to +40°C. 15% to 93% RH. 700 hPa to 1060 hPa.
Storage conditions	-25°C to +70°C. Max 93% RH. 500 hPa to 1060 hPa.
Warm up time in 20° environment (-25°C to 5°C)	15 minutes
Cool down time in 20° environment (70°C to 40°C)	18 minutes

FACTORY SETTINGS

In time mode, the pump is supplied with the following settings:

Infusion duration	10 h
Infusion end acoustic signal	AL,1 (active)
Partial volume	50 ml
Access level	L 0 (complete)
Number of infusions	0

In the flow rate mode the following parameters are set:

Flow rate	5 ml/h
Infusion end acoustic signal	AL,1 (active)
Number of infusion sites	IP,1
Partial volume	50 ml
Access level	L 0 (complete)
Number of infusions	0

INFORMATION

For further information about the **CRONO S-PID 50** pump contact:



Customer Service Assistance
401 Southwestern Blvd., Suite 160
Coppell, TX 75019 USA
Tel: 1-866-211-7867
www.intrapump.com

SECTION 5

EQUIPMENT

1. **CRONO S-PID 50** portable syringe pump.
2. Infuser holder case.
3. Elastic belt.
4. Support cord.
5. Fabric case.
6. 2 batteries (1 of which is inside the pump).
7. Instruction manual.
8. Accessory battery compartment door opener.



OPTIONAL ACCESSORIES AVAILABLE ON REQUEST

1. Heightwise leatherette case similar to a cellular phone holder.

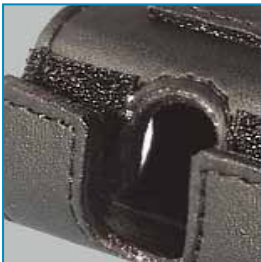
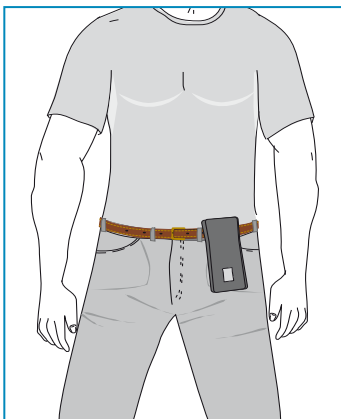
Detail
openingDetail
belt clip**Color:** black**Size:** 12 x 5.5 x 4 cm**Weight:** about 60 g**Article code:** CM/11

2. Lengthwise leatherette case similar to a glasses case.



Detail of belt loop



Color: black

Size: 12 x 5.5 x 4 cm

Weight: About 50 g.

Article code: CM/10

3. Specific hard case with prime button that can be activated from the outside, a window that allows you to see the display and black elastic belt.

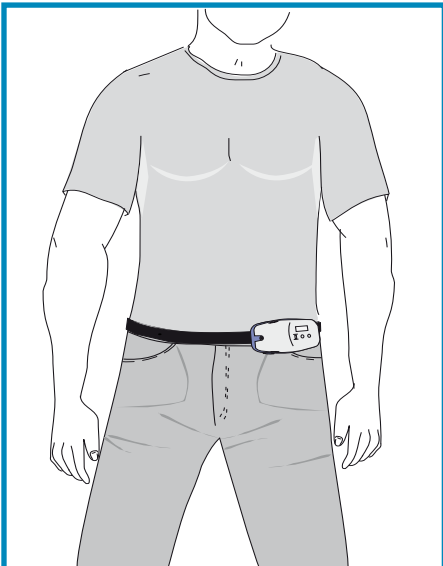

Color: semitransparent upper casing, blue lower casing.

Size: 12 x 5.5 x 4 cm

Weight: About 75 g.

Article code: CM/12

SECTION 5

HOW TO USE THE ACCESSORIES PROVIDED

The figures below provide indications on the use of the accessories supplied with the pump.

PUMP WORN AROUND THE NECK

Pump worn with the support cord and the fabric case.

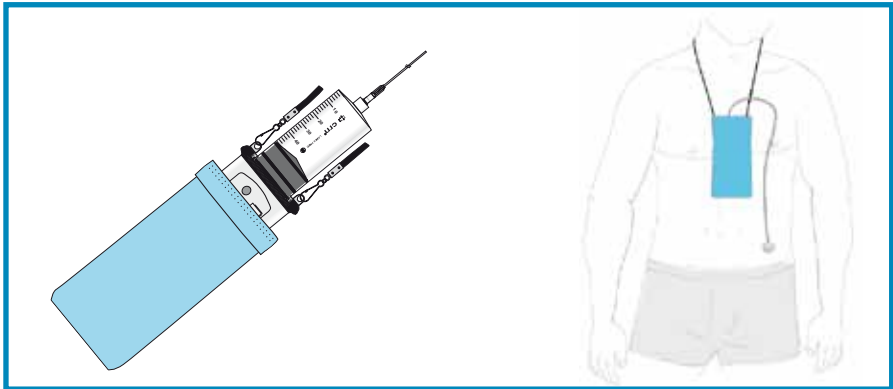

PUMP WORN AROUND THE WAIST

Pump worn with the elastic belt and the fabric case.

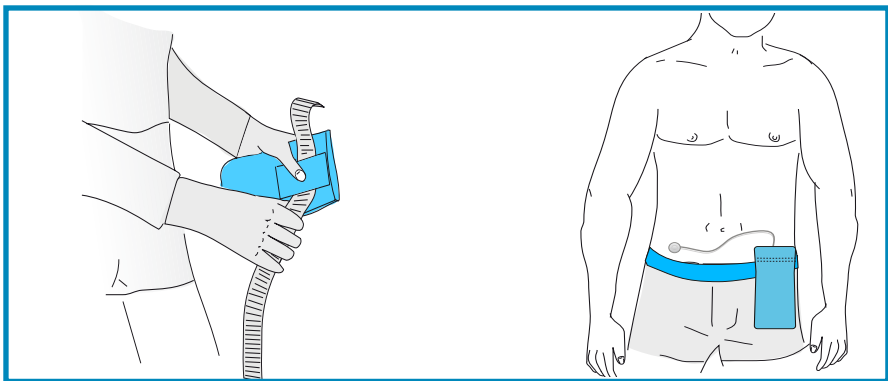

IDENTIFYING THE DEVICE COMPONENTS

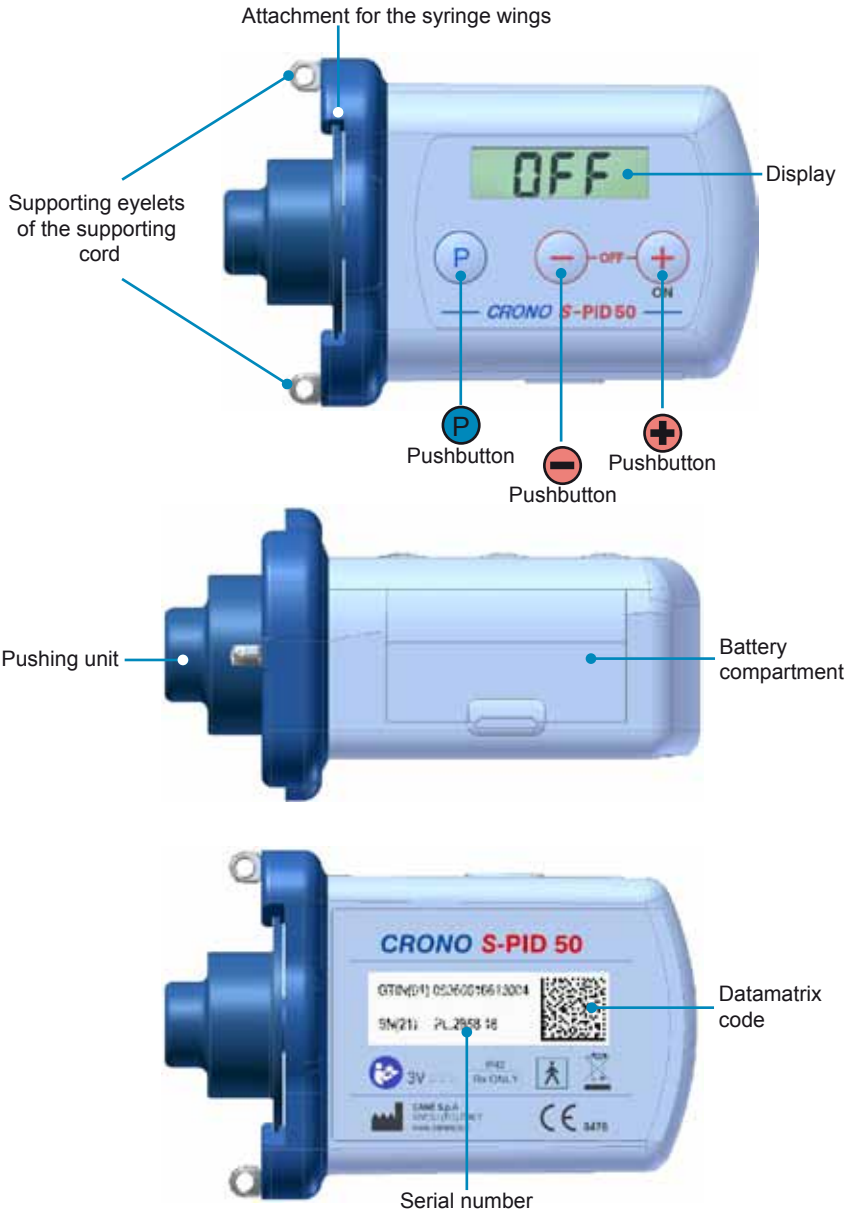

LIQUID CRYSTAL DISPLAY

The liquid crystal display shows text messages and symbols in order to provide the user with information concerning settings, operations in progress and error situations.

The “Low Battery” symbol:

appears when the battery is low (see the relevant paragraph on page 55).

The “Drop” symbol:

separates internal numbers from decimals.

The “Prime Minutes” symbol:



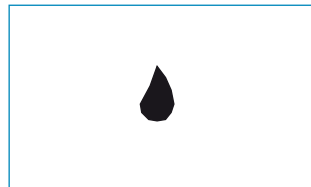
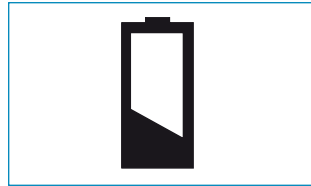

is shown when the duration of the infusion is expressed in minutes.



EXAMPLES OF INDICATIONS APPEARING ON THE DISPLAY

Display upon inserting the battery	8888
Firmware version	0200
Selecting program type (time)	-t-
Selecting program type (Flow rate)	-F-
Continuous pushing unit progression/withdrawal	└---
Pump switch off (OFF condition)	OFF
Time remaining until the end of the infusion	800
Flow rate (ml/h)	F 1
Infusion end acoustic signal on	AL1
Infusion end acoustic signal off	AL0
Number of infusion sites (Infusion Point)	IP5
Partial volume	45cc
Partial volume: Starting the positioning of the pushing unit	Pcc
Infusion end (End)	End
Keypad locked (Lock 1)	L1
Keypad unlocked (Lock 0)	L0
Occlusion	OCCL

SECTION 6

Administered medication volume fraction (flow rate mode)	
Number of infusions performed	
Error message	
Low battery	
Battery dead	

NOTE



The displays shown only represent an example of what may be displayed.



KEYPAD

The keypad consists of 3 push-buttons.

The pushbuttons are timed: they must be pressed for a few seconds before the command is executed.

Pressing the pushbuttons is confirmed by an acoustic signal similar to a ticking noise.

The execution of the commands is validated by a short acoustic signal.

While selecting the parameter, the pushbutton  is used to decrease the value displayed, the pushbutton  to increase the value displayed.

The pushbuttons have different functions according to the condition that the pump is in:

- Battery insertion
- Switched off (**OFF** condition)
- In operation (**ON** condition).

**Warning**

The pushbuttons must be pressed with your fingertips only; do not use pointed objects.



SECTION 7

RESERVOIR

The **CRONO S-PID 50** pump uses a 50 ml specific reservoir.

Features of the reservoir:

- Sterile.
- Disposable.
- Apyrogenous.
- Do not use if the package is damaged or open.

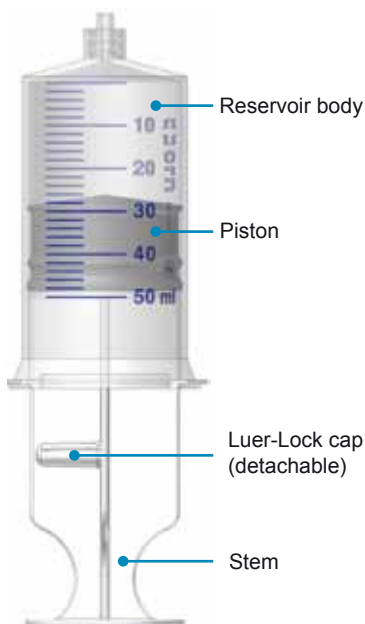

Warning



For safety purposes the use of original CRN® Crono® Reservoir syringes is recommended.

The use of reservoirs of other types may damage the pump and harm its user.

CANÈ S.p.A. is exempt from any responsibility should the device be used with other syringes than those recommended.

LUER LOCK CAP

The *Luer lock* cap is connected to the stem of the reservoir from which it is detached by applying a little pressure. Functions of the *Luer Lock* cap:

- After filling the reservoir it assists in unscrewing the stem from the piston, avoiding spilling the medication;
- It assists in the correct connection between the pushing unit of the pump and the rubber piston of the syringe;
- It protects the medication inside the reservoir in case it is not immediately used.



SECTION 7

FILTRAJET

For a safe infusion the use of a filter is advised to:

- prevent possible infections due to bacteria;
- remove air from inside the reservoir and the infusion set;
- retain micro-particles such as glass and plastic fragments.

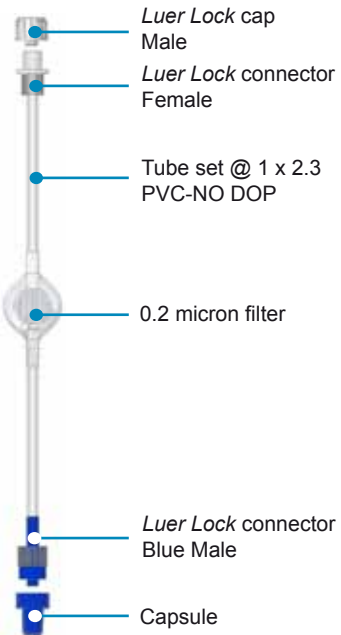

Y-SET

It is possible to infuse the medication in two different infusion sites at the same time by using a Y set.



Warning

The Y set does not guarantee that the medication is equally subdivided in both the infusion sites.

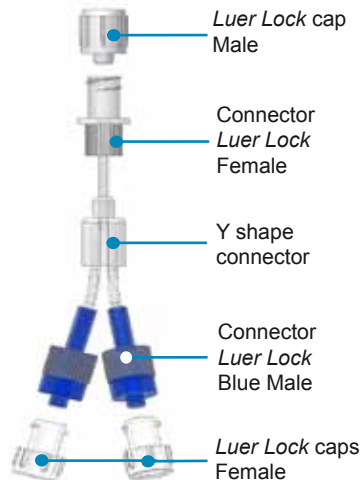

INFUSION SET

The use of an infusion set with the following characteristics is advised:

- Reduced tube internal volume (optimal 0.1 ml, maximum 0.62 ml);
- Tube not longer than 90 cm;
- Kink resistant tube.

IDENTIFYING THE INFUSION SET COMPONENTS

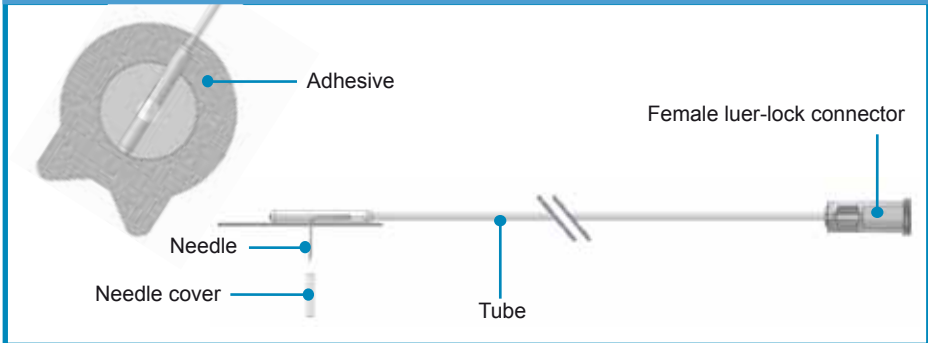

PREPARING FOR THE INFUSION

Before preparing the material necessary for the infusion it is advisable to take the following precautions:

1. wash your hands;
2. create a clean work area.

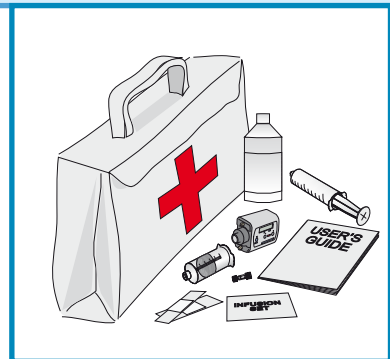

SECTION 7

PREPARING THE RESERVOIR

Refer to the Medication's Instructions for Use when selecting the appropriate device for transferring of the medication from the vial into the Crono Syringe. Fill the reservoir by slowly draw up the liquid and checking that the quantity of medication does not exceed the capacity of 50 ml or the partial volume set;

1. Screw the reservoir to the *Luer Lock* cap (1) or the infusion set and unscrew the stem of the syringe by rotating it anticlockwise with a fairly rapid movement (2).
2. Attach the reservoir to the pump with a rotation of 90°, a click confirms that it is locked into place (see page 32);
3. Screw the reservoir to the cone of the infusion set.



ATTACHING THE RESERVOIR TO THE DEVICE

Attach the specific CRN 50 reservoir to the pump with a rotation of 90°: a click will confirm that it is locked into place.



Front view

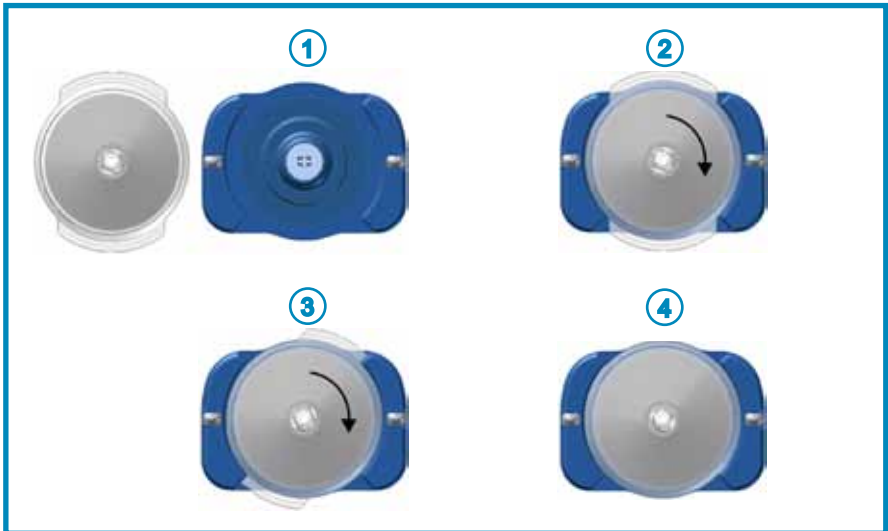

WARNING**1 - Before filling the reservoir**

Unscrew the stem from the piston and screw it back onto the stem to facilitate unscrewing after filling the reservoir.

Slide the piston across the syringe body a couple of times to distribute the lubricant along the walls.

Detach the *Luer Lock* cap from the stem.

2 - Filling the reservoir

The liquid must be drawn up slowly.

The reservoir must not be filled beyond the maximum volume allowed of 50 ml.

The stem must be unscrewed with a fairly rapid movement.

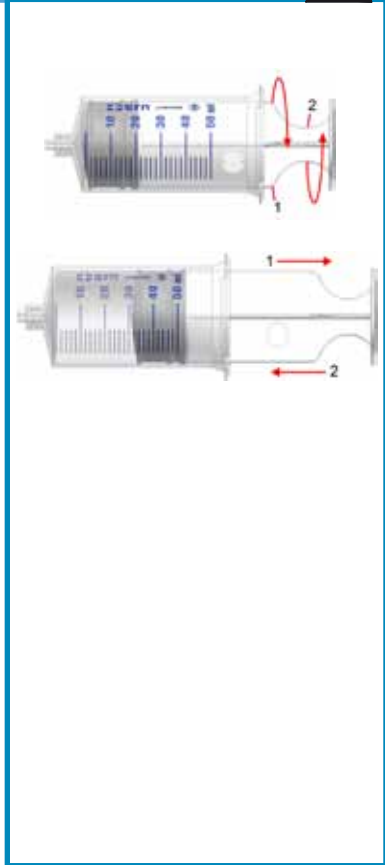

3 - Attaching the reservoir to the pump

To prevent any leakage of medication while engaging the reservoir to the pump it is possible to use, as an alternative to the *Luer Lock* cap the infusion set indicated on page 27.

The reservoir, while being attached to the pump, must be held as shown in the figure.



Do not put pressure on the syringe walls while connecting the syringe with the dispenser since this may cause liquid to leak from the piston rings.



During reservoir filling and attachment to the pump, some liquid may leak between the first and the second seal ring of the rubber piston: this condition does not jeopardize either correct operation of the syringe or the delivery of the liquid.









SECTION 8

KEYPAD LOCK

The **CRONO S-PID 50** pump has 2 access levels to the functions:

- **L 0** (full access): provides full access to parameter settings and the pump functions.
- **L 1** (limited access): provides partial access to the pump functions but does not allow the modification of the settings.

The table below lists the operations possible in the **L 1** condition.

Function/operation	Pushbuttons
Switching the pump on	
Switching the pump off	 + 
End (OFF)	 + 
Infusion number display	 (7 seconds)
Flow rate switching/infusion duration (ON)	
Prime function*	

* **Limitation:** a maximum of 10 0.2 ml doses can be administered in the first 2 minutes from the infusion start. Every attempt to administer a dose after the 2 minutes will be signaled with the error message **Er,d**; by switching the pump off and turning it back on again the estimate of the minutes and doses restarts from 0 and therefore the filling function of the infusion set is available again.

NOTE



The access level remains in the memory even if the battery is removed.

Warning



The information concerning access level selection is provided separately and is reserved for doctors.

INITIALIZATION OF THE PUMP

When the battery is installed the pump begins the start up sequence during which:

1. It performs a self diagnosis emitting short acoustic signals and the display shows all the symbols.
2. The display shows the firmware version for a few seconds (useful information for the Customer Support).
3. The indication of the previously selected programming mode.
4. It performs the mechanical positioning of the pushing unit up to the infusion start position, at the end of which the display shows the indication **OFF**.







NOTES





- The pump is supplied with a battery already inserted.
- For instructions on how to install the battery please see the relevant paragraph on page 56.
- It is worthwhile performing the initialization of the pump should the device not be used for a long period (1-2 months) and the battery not have been removed.
- If after inserting the battery (pump initialization) the display does not show the information previously indicated, it is worthwhile taking the battery out and putting it back in again.

SETTING AND INSERTING THE BATTERY

When inserting the battery, it is possible to select the programming mode of the pump:

- 1 - flow rate expressed in ml/h (-F-) or,
- 2 - time expressed in hours and minutes (-t-).

Procedure

- 1 - Taking out the battery and putting it back in again.
- 2 - The display shows all the symbols.
- 3 - At the same time the device performs a self diagnosis during which it emits acoustic signals.
- 4 - The display shows the firmware version for a few seconds.
- 5 - Subsequently the display shows the programming mode indication -F- (flow rate) or -t- (time): by pressing the pushbutton  for 4 seconds the indication flashes, pressing the pushbutton  you pass from one option to another.
- 6 - By not pressing any of the pushbuttons for about 4 seconds the device saves the selected parameter.
- 7 - Subsequently the pump performs the mechanical positioning of the pushing unit at the infusion start and the display shows **OFF**.

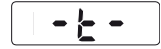

NOTE

Setting the programming mode is only possible in the **L 0** access level condition.

Warning

The selection of the programming type of the pump (flow rate or time) is the responsibility of the doctor, who will choose the most suitable mode.



SETTINGS IN THE OFF CONDITION



In the **OFF** condition the following parameters can be set:



- 1 - Infusion end acoustic signal
- 2 - Number of infusion points (function in flow rate mode only)
- 3 - Partial volume

The selection of the parameters in the **OFF** condition may be performed only in the following conditions:

- pump **OFF**;
- keypad unlocked;
- at the start of a new infusion (partial or total).

To access the settings press the pushbutton  for about 1 second: the display shows the **setting phase of the infusion end acoustic signal**. Varying the setting of the parameter is possible (activation/deactivation) while the value on the display flashes by using the pushbuttons  and .

By pressing the pushbutton  again the display shows the setting phase of the **number of infusion points**. Varying the setting of the parameter is possible while the value on the display flashes by using the pushbuttons  and .

By pressing the pushbutton  again the display shows the setting phase of the **partial volume**. Varying the setting of the parameter is possible while the value on the display flashes by using the pushbuttons  and .



SECTION 10

NOTES



- Setting the infusion end acoustic signal, the number of infusion points and the partial volume is only possible in the **L 0** access level condition.
- In keypad lock active condition at every attempt to vary the parameter the display shows the indication **L 1**.

FLOW CHART OF SETTINGS IN THE OFF CONDITIONS

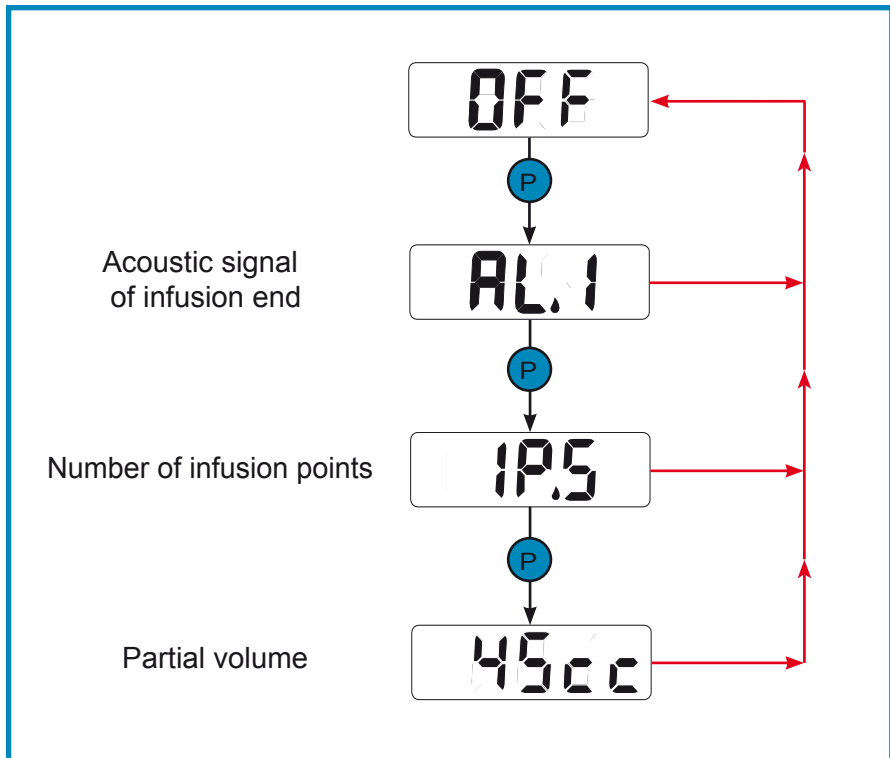

The displays shown represent an example: the data shown depends on what has been selected previously.

1 - INFUSION END ACOUSTIC SIGNAL

- 1 - In the **OFF** condition press the pushbutton **P**: the pump is now in the infusion end alarm selection.
- 2 - When the indication **AL,0** or **AL,1** flashes, the pushbuttons **-** and **+** enable the selection to be made.

AL0 Infusion end acoustic signal off.

AL.1 Infusion end acoustic signal on.

NOTE



In keypad lock active condition at every attempt to vary the parameter the display shows the indication **L 1**.

2 - SETTING THE NUMBER OF INFUSION POINTS

In the event that a medication volume needs to be administered by breaking it up into several Infusion Points (**IP**), the pump allows up to 5 points to be selected, performing partial subsequent deliveries.

The setting of this parameter is accessed by pressing again the button **P** (see sequence on page 39).

It is possible to select the number of infusion points **IP,1** (the indication of the number of points flashes) to which the medication volume to be delivered can be administered; select it by using the pushbuttons **-** and **+**; the number of points can be selected from **1** to **5**:

- by selecting **1** you choose to administer the medication contained in the syringe to one single infusion point;
- by selecting **2** you choose to administer 50% the medication contained in the syringe to one infusion point and subsequently the other 50% to another infusion point;
- by selecting **3** you choose to administer the medication contained in the syringe to 3 different infusion points (33% per point) and so on **4** (25% per point) and **5** (20% per point).

SECTION 10

By selecting a number of infusion points between 2 and 5, for example 4, the pump will administer the medication as follows:

- 1 - the first fraction of the medication volume contained in the syringe will be administered to one infusion point, the pump will subsequently stop and show the indication **End** on the display, while emitting an intermittent acoustic signal of partial infusion end until the next fraction is delivered.
- 2 - the display will subsequently alternate showing the indication **End** and **1-4** (fraction 1 of 4 administered);
- 3 - in this phase the patient may replace the infusion set, restart the pump by pressing the pushbutton , run the priming, change the infusion point and continue with the infusion;
- 4 - for the subsequent infusion points the pump shall proceed in the same way described above, indicating **End** alternating with **2-4**, **End** alternating with **3-4** and finally **End** concluding the fractioning of the infusions and with the return of the pushing unit to the infusion start position.



End



End



1-4



End



2-4

NOTE



This function is available only if the pump flow rate is programmed (-F-).

Warning



Every time the infusion point changes, check, by means of suction with a normal syringe, that the needle has not been introduced into a vein or a capillary (for further details on the procedure to use, please refer to your family doctor).

3 - SETTING THE PARTIAL VOLUME

The partial volume function is recommended if the therapy does not need infusions with the maximum volume allowed of 50 ml.

The setting of the partial volume can be changed from 5 cc to 50 cc with stages of 1 cc.

The setting of this parameter is accessed by pressing again the button **P** (see sequence on page 39).

The partial volume function can be set only before starting a new complete (50 ml) or partial infusion.

The procedure is as follows:

1. The display shows the flashing indication of the volume followed by the indication cc indicating the volume unit (1 cc = 1 ml).
2. Press the **+** pushbutton to increase this value; press the **-** pushbutton to increase it. Each variation is confirmed by an acoustic signal.
3. Once the setting is complete, if no pushbutton is pressed for 5 seconds, the display will show the indication **P,cc**.
4. The pump will move the pushing unit to the position corresponding to the set volume: in real time the display will show the volume corresponding to the position of the pushing unit with stages of 1 ml and during this phase an acoustic signal will be emitted every time the displayed volume varies.
5. After having positioned the pushing unit, the display shows the indication **OFF**.







SECTION 10

NOTES



- The value of the partial volume set is automatically saved by the pump.
- At the end of an infusion, the pushing unit withdraws to the position corresponding to the selected partial volume.
- The partial volume function may be interrupted by pressing the pushbuttons  and  at the same time: the device switches itself off (the display reads **OFF**) and the pushing unit remains in the position in which the interruption took place.

If the partial volume is lower than the set volume (the pushing unit progresses): the partial volume is not saved in the memory and the previously set one remains active.

If the partial volume is higher than the set volume (the pushing unit withdraws): the display shows **OFF** alternating with **P,cc**. The only possible operation is to restore the withdrawal by pressing the pushbutton . The pushing unit continues its withdrawal towards the set partial volume.

Warning



- This operation must be performed with the infusion set disconnected from the reservoir.
- A partial volume can not be set during an infusion.
- The setting of the partial volume remains in the memory until the battery is removed: upon inserting the battery the partial volume is always set to 50 ml.

SETTINGS IN THE ON CONDITION

In **ON** conditions the following parameters can be set:

- 1 - Infusion duration (if the time mode was selected upon inserting the battery).
- 2 - Flow rate (if the flow rate mode was selected upon inserting the battery).





SETTING THE INFUSION DURATION

This function is only available if, upon inserting the battery, the function “-t-” (time) was selected.



The setting of the time value can be changed from 1 to 50 h with 15' stages.

The time parameter can be changed during an infusion.

Procedure:

- 1 - Press the pushbutton  to switch on the pump.
- 2 - By pressing the  pushbutton, the pump accesses the infusion duration programming phase, with the time flashing on the display.
- 3 - While the indication is flashing, the parameter can be changed by using the pushbuttons  or .
- 4 - By not pressing any of the pushbuttons for about 5 seconds the device saves the selected parameter and the infusion continues.

NOTES

- In keypad lock active condition the setting of the infusion duration is not accessible, at every attempt to vary the parameter the display shows the indication **L 1**.
- Continuously pressing the  or  pushbutton allows a rapid variation of the infusion duration values with 30' stages.





FLOW RATE SETTING

This function is only available if, upon inserting the battery, the function “-F-” (flow rate) was selected.

The value of the flow rate can be set from 1 to 50 ml/h with 1 ml/h stages.

The flow rate parameter can be changed during an infusion.



Procedure:

- 1 - Press the pushbutton  to switch on the pump.
- 2 - By pressing the pushbutton  the pump accesses the flow rate programming phase, with the indication flashing on the display.
- 3 - While the indication is flashing, the parameter can be changed by using the pushbuttons  or .
- 4 - By not pressing any of the pushbuttons for about 5 seconds the device saves the selected parameter and the infusion continues.





NOTES

- In keypad lock active condition the setting of the flow rate is not accessible, at every attempt to vary the parameter the display shows the indication **L 1**.
- Continuously pressing the  or  pushbutton allows a rapid variation of the flow rate values at 2ml/h steps.



SWITCHING ON THE PUMP IN TIME MODE

From the **OFF** condition, when the  pushbutton is pressed, the device emits a short acoustic signal and the display shows in sequence:

- 1 - The partial volume (if previously programmed);
- 2 - The indication of the programmed infusion duration;
- 3 - The indication of the time left until the end of the infusion.

45cc5.004.45**NOTE**

Every time the pump is switched off, the display will show the indication of the programmed infusion duration upon switching it on again, and subsequently the time left until the end of the infusion.

SECTION 11

SWITCHING ON THE PUMP IN FLOW RATE MODE

From the **OFF** condition, when the  pushbutton is pressed, the device emits a short acoustic signal and the display shows in sequence:

- 1 - The partial volume (if previously programmed);
- 2 - The number of infusion points (function in flow rate mode only);
- 3 - The programmed flow rate (if selected **-F-**);
- 4 - The indication of the time left until the end of the infusion.



45cc



1P5



F 10



5.00

NOTES



- It is possible to display the set flow rate rather than the time left until the end of the infusion by pressing the pushbutton ; the letter **F** indicating the flow rate flashes on the display. This function is available only if flow rate is the initial setting.
- Every time the pump is switched off, the display will show the time left until the end of the infusion upon switching it on again.

PUMP IN OPERATION

When the pump is operating the display shows the duration of the infusion expressed in hours and/or minutes:



- if the pump is set to time (-t-) the time decreases by 15 minute stages up to an hour, subsequently it decreases minute by minute;
- if the pump is set to flow rate (-F-) the time decreases minute by minute.

5.15

49'

5.36



INFUSION SET REFILLING (PRIME)

- 1 - Press the pushbutton  to switch on the pump.
- 2 - To begin the infusion it is necessary that the pushing unit makes contact with the piston of the syringe; otherwise, make the piston move forward by pressing the pushbutton . Each time it is pressed the pushing unit progresses by a volume of 0.2 mm.
- 3 - Perform this action until some drops of the medication come out of the needle.

5.00

t - - -

NOTES

- The Prime function may be interrupted by pressing the pushbuttons  and  at the same time, the device returns to the **ON** condition.
- During priming the flow rate is approximately 217 ml/h.



- If the keypad is locked, a maximum of 10 0.2 ml doses can be administered in the first 2 minutes from the infusion start. Every attempt to administer a dose after the 2 minutes will be denied and signaled with the error message **Er,d**; by switching the pump off and turning it back on again the estimate of the minutes and doses restarts from 0 and therefore the filling function of the infusion set is available again.





This function allows the infusion line to be filled in case the infusion set needs to be replaced.

WITHDRAWAL

1 - Total anticipated withdrawal

The infusion in progress can be interrupted and the pushing unit returned to the position it was in at infusion start.

To perform a total withdrawal, proceed as follows:

- Switch the pump off by pressing the push-buttons  and  at the same time.
- Press the pushbuttons  and  at the same time, the display shows **End** for 10 seconds and subsequently starts the withdrawal of the pushing unit.

OFF

End

2 - Infusion end withdrawal

If **AL,1** is set (active infusion end acoustic signal) at the end of the infusion a continuous acoustic signal is emitted and the display shows the message **End**.

The pushing unit automatically returns to the position it was in at infusion start in the **OFF** condition.

End

OFF



PUSHING UNIT MOVEMENT

When the pushing unit performs a continuous withdrawal movement, the symbol “Continuous pushing unit withdrawal” appears on the display.

| t - - -

NOTES



- The anticipated withdrawal and infusion end withdrawal functions may be interrupted by pressing the pushbuttons  and  at the same time. This condition is highlighted by the indications **End** and **OFF** alternating on the display. In this state, the only active pushbutton  is which restores the withdrawal when pressed.
- Should an anticipated withdrawal be requested when the pushing unit has already begun the infusion, the device emits an acoustic signal and the display shows **Err** (operation can not be performed).



Err

OCCLUSION

The pump has been designed to recognize when the administration of the medication is interrupted due to external causes, such as squashing or kinking the infusion set tube, with consequent occlusion.

A digital display showing the text 'OCCL' in a black, segmented font on a white background.

During the state of occlusion, the administration of the medication is interrupted: to continue with the infusion press the pushbutton  after having removed the cause of the occlusion.

NOTES



- The cause of the occlusion is to be found along the path of the medication in the infusion set and in the point of intersection of the set in the patient.
- To prevent or minimize occlusions, the use of infusion sets with an anti-kink tube is advised.

POST-OCCLUSION BOLUS

The occlusion alarm signal is emitted when the pump detects an overpressure in the infusion line; this overpressure must be limited in order to avoid the accidental release to the patient of the post-occlusion bolus, which may cause serious injury.

The volume of a post occlusion bolus of the **CRONO S-PID 50**, considering the pump-syringe set only, is approximately 1.8 ml.

SECTION 11

Warning



- The volume of the bolus released after a condition of occlusion may vary depending on the type of catheter, the infusion set and all the elements in the infusion line.
- Another element that may affect the volume of the bolus released after a condition of occlusion is the possible presence of air in the system.
- After an occlusion has been signaled, if necessary, take adequate measures to prevent the administration of a post-occlusion bolus to the patient.

INFUSION END





Five minutes before the end of the infusion the device emits an intermittent acoustic signal which lasts 2 seconds.

At the end of the infusion a continuous acoustic signal is emitted (if **AL,1** is selected) and the display shows the **End** message, subsequently the pushing unit begins to withdraw up to the infusion start position and the display shows the symbol “continuous withdrawal”.





NOTES



- The infusion end withdrawal may be interrupted by pressing the pushbuttons  and  at the same time. This condition is highlighted by the indications **End** and **OFF** alternating on the display. In this state, the only active pushbutton is  which restores the withdrawal when pressed.
- The final phase of the withdrawal (about 3 seconds), identifiable by a net reduction in speed, can no longer be interrupted by pressing the pushbuttons  and  at the same time.
- The duration of the withdrawal for a volume of 50 cc is about 6 minutes; the duration is proportionally lower for lower volumes.

SWITCHING OFF

To switch off the device, press the pushbuttons  and  at the same time, the display shows the **OFF** indication.



INFUSION NUMBER DISPLAY

To view the number of complete infusions performed the pump must be switched off (**OFF**).



To access the display press the pushbutton  for about 7 seconds: the number of complete infusions performed appears on the display.



SAVING OF SET DATA

The selected data concerning: infusion end alarm, time or flow rate, infusion number and keypad lock, is automatically saved.

The data remains in the memory even if the battery is removed.

The data relating to the partial volume does not remain in the memory if the battery is removed.

BATTERY LOW WARNING

The fixed symbol “**LOW BATTERY**” appearing on the display indicates that the battery is low.

If this symbol remains for some consecutive infusions, the indication “**DEAD BATTERY**” will subsequently appear; in this situation, the device remains locked and will emit an intermittent acoustic signal for one minute, followed by a minute of standby and then by a continuous acoustic signal until the battery is replaced.

Users are advised to replace the battery immediately after the symbol “**LOW BATTERY**” appears, at the end of the infusion in progress.

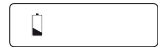
**Warning**

- Users are advised to replace the battery immediately after the symbol “**LOW BATTERY**” appears.
- Replacing the battery must not be performed:
 - during an infusion;
 - with the infusion set connected to the patient.

REPLACING THE BATTERY

1. Open the battery compartment door with the opener or with a paperclip;
2. Remove the cover;
3. Pull the strip of cloth located under the battery, to remove the battery;
4. Take out the dead battery;
5. Insert the new battery respecting the polarity indicated and taking care to place the extraction strip underneath it;
6. After inserting the battery, close the compartment door.

Should it not be possible to extract the battery with the strip, do not use another object and proceed as follows:

- Hold the device firmly in your right hand;
- Gently tap the palm of your left with your right hand to make the battery come out.

NOTES

- After inserting the battery, the battery performs a self diagnosis during which it emits short acoustic signals and the display shows all the symbols.
- In normal conditions of use, the battery's life is around 3/6 months or 60-80 infusions.
- During the replacement of the battery, the pump stores the data set in the memory; the only data not saved concerns any partial volume programming.
- Make sure that the battery compartment door is correctly closed.
- The door is fitted with a silicone seal that must remain in its lodging.

REPLACING THE BATTERY

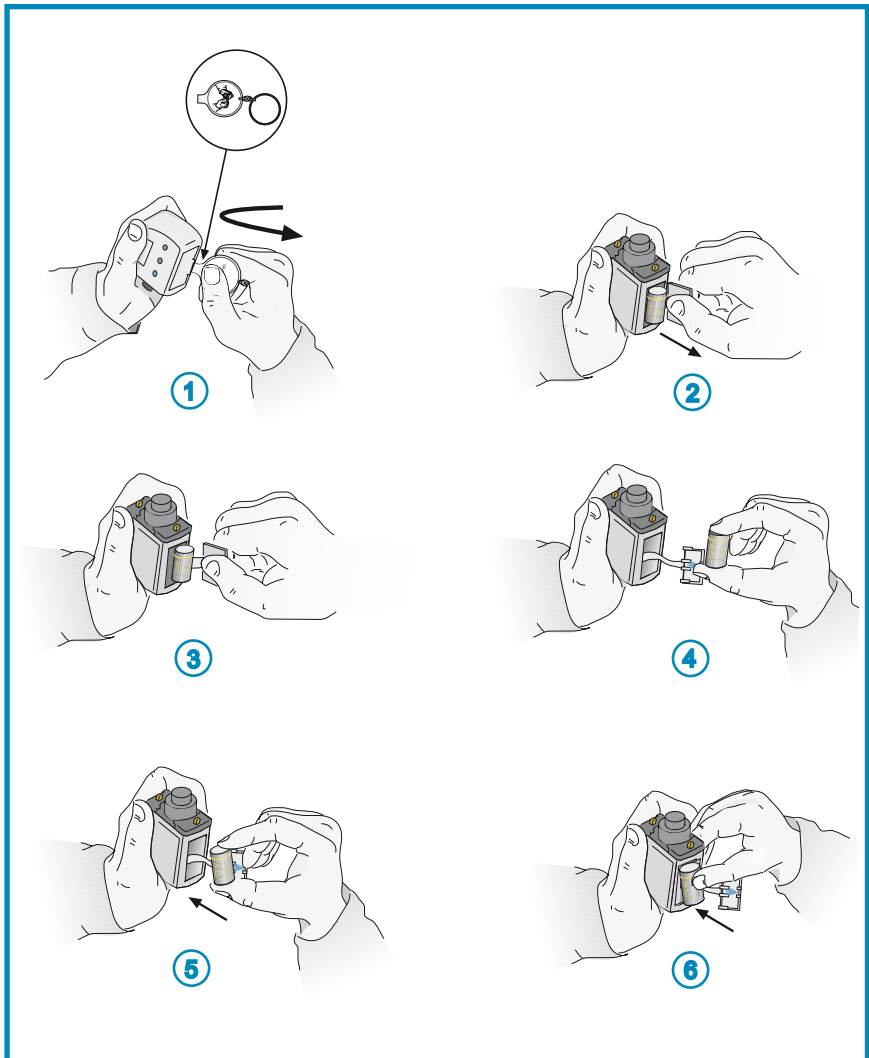

BATTERY CARE

- Only use 3 Volt Lithium batteries model CR 123 A.
- Using other batteries may cause the device to malfunction.
- The above mentioned batteries are available in all good photographic stores.
- Do not use rechargeable batteries.
- In normal conditions of use, the battery's life is around 3/6 months - 60/80 infusions. It is worthwhile keeping a backup battery.
- The battery's life can be influenced by its age, storage method and temperature.
- In the case that the device is not used for long periods, it is worth removing the battery from its compartment.
- Always make sure that the battery compartment door is closed correctly.
- Used batteries must be disposed of appropriately by using specific containers.

SECTION 13

GENERAL WARNINGS



- The device can be damaged by infiltration of liquids, therefore it must not be used while having a bath, a shower, etc. Should liquid accidentally penetrate the device (e.g. drops of medication), it is necessary to have it checked by CANÈ S.p.A.'s Assistance Center.
- The device must be kept away from:
 - heat sources (radiators, ovens, heaters);
 - direct sunlight (the fabric case is not adequate protection);
 - intense electromagnetic fields (magnets, speakers, car radio equipment), details are provided in ATTACHMENT 3;
 - ionizing radiation;
 - ultrasound devices;
 - magnetic resonance devices.
- The device does not need to be sterilized.
- Do not freeze the CRN syringes with medication inside.
- The device must not be placed in a fridge or freezer.
- The device must not be placed in an oven or microwave.

Not respecting the indications stated in the above mentioned warnings, the device may malfunction with serious consequences for the user.

MANUAL UPDATES

The version and the publication date of this instruction manual are reported on every page of the document. If a year passes from the publication date (reported on page 2) and the product being used, the doctor must contact CANÈ S.p.A. to check if there is a more recent version of the manual.

MAINTENANCE

The technical characteristics of the device make the amount of maintenance required extremely low.

If the device is damaged, we recommend having it checked by the CANÈ S.p.A. Customer Support before using it again.

CLEANING AND DISINFECTION

The infusion pump is a reusable medical device that should be kept clean. The pump must be regularly cleaned in the following way:

Suggested equipment:

- disposable gauzes
- mild neutral detergent
- 70% isopropyl alcohol (IPA) disinfectant
- water at room temperature.

Procedure:

- 1) Dampen a gauze with water mixed with the detergent, and wipe the outer pump surfaces.
- 2) Moisten a gauze with water and wipe to remove any detergent residue, then dry with a new gauze.
- 3) Moisten a gauze with the disinfectant and wipe the outer pump surfaces.
- 4) After evaporation of the disinfectant, wipe with a moist gauze to remove any residue of disinfectant from the outer pump surface, then dry with a new gauze.

SECTION 14

GENERAL WARNINGS



- The infusion pump must not be immersed in fluids.
- Should the device get wet, dry it immediately with paper towels to avoid the penetration of liquids into the infusion pump.
- Disinfect the pump before changing the user.
- Do not clean the pump with acetone, solvents or abrasive detergents.
- Do not sterilize the pump.

STORAGE

If the device is not used for a period exceeding 2/3 months, we advise removing the battery and placing it inside its case in a dry place at room temperature.

DISPOSAL

At the end of the life of the pump, contact the CANÈ S.p.A. Customer Support, which will provide the necessary indications for the collection and disposal of the device.

Reservoirs, infusion set, filters, and all the material used must be disposed of appropriately, by using specific containers.

EXPECTED LIFE OF THE PUMP

The expected life of the pump is 4 (four) years starting from the purchase date; for safety reasons, it must not be used after this period.

CUSTOMER SUPPORT

The device must only be repaired by the CANÈ S.p.A. Customer Support. Before sending the device we advise contacting:



Customer Service Assistance
401 Southwestern Blvd., Suite 160
Coppell, TX 75019 USA
Tel: 1-866-211-7867
www.intrapump.com

Customer Support Service

CANÈ S.p.A. Medical Technology
Via Cuorgnè, 42/a
10098 Rivoli (Turin) - Italy
Tel. +39.011.9574872 - Fax +39.011.9598880
Internet: www.canespa.it - E-mail: service@canespa.it

WARRANTY REGULATIONS

With this warranty CANÈ S.p.A. guarantees the product from any faults in materials or manufacturing faults for the duration of 2 (TWO) years starting from the original purchase date.

Should faults in materials or manufacturing faults be found during this warranty period, CANÈ S.p.A. shall repair or replace the faulty components under the terms and conditions stated below, without any charge for the costs of manpower or spare parts; the cost of sending the device to the CANÈ S.p.A. Customer Support shall remain on the Customer's account.

CANÈ S.p.A. reserves the right to vary the characteristics or the model of its devices, with no obligation to make changes to already manufactured and sold devices.

Conditions:

1. The warranty shall only apply if the fault is claimed within the terms of the warranty.

2. This warranty does not cover the costs and/or any faults due to modifications or adaptations made to the product, without prior written authorization issued by CANÈ S.p.A.

CANÈ S.p.A. declines any responsibility towards purchasers or third parties, which may concern people or objects due to improper use of the device, not intended use and due to non-compliance with the regulations reported in the instruction manual. The buyer undertakes to exempt CANÈ S.p.A. from any claim made by third parties concerning the above.

3. This warranty is void if the model indication or the serial number indicated on the product have been modified, deleted, removed or in any case made illegible.

4. The following is excluded from the warranty:













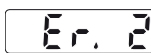

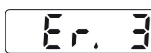
- Periodic maintenance interventions;
- Damage due to improper use, including but not limited to:
 - incorrect electrical power supply;
 - use of the product for purposes other those it is intended for;
 - repair interventions performed by unauthorized personnel or by the Customer;
- Unforeseeable and accidental events, such as falls and infiltration of liquids;
- Natural events and malicious or culpable actions;
- The accessories provided with the pump.

5. CANÈ S.p.A. undertakes, for a period not exceeding 4 (four) years from the purchase date, to perform repairs to the device.

After this period CANÈ S.p.A. is exempt from the obligation to repair. CANÈ S.p.A. declines any responsibility towards purchasers or third parties, for damages which may occur during the use of the device after 4 (four) years from the purchase date.

6. After the warranty expires, assistance shall be provided by CANÈ S.p.A. which charges for the replaced components, manpower and transportation in force at the time.

SIGNALING ERRORS

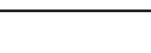
CODE	ACOUSTIC SIGNAL ERROR DESCRIPTION	CORRECTIVE ACTION
	THIS OPERATION CAN NOT BE PERFORMED	CONSULT THE MANUAL PAGE 51
	ACOUSTIC SIGNAL WHEN PRESSING THE PUSHBUTTON/S	
	RESET INCORRECT	INITIALIZE THE DEVICE AGAIN
	CONTINUOUS ACOUSTIC SIGNAL	
	PROBLEM WITH THE SAFETY SYSTEM	PRESS THE PUSHBUTTON 
	CONTINUOUS ACOUSTIC SIGNAL	
	MOTOR CIRCUIT FAULT	PRESS THE PUSHBUTTON 
	INTERMITTENT ACOUSTIC SIGNAL REPEATED APPROX. EVERY 10 SEC.	
	MECHANICAL LOCKING OF THE PUSHING UNIT IN THE WITHDRAWAL PHASE (MAY BE CAUSED BY A FOREIGN BODY WHICH IMPEDES ITS RETURN)	ELIMINATE THE CAUSE AND INITIALIZE THE DEVICE
	INTERMITTENT ACOUSTIC SIGNAL REPEATED APPROX. EVERY 10 SEC.	
	FAULT OF THE PROGRESSION SYSTEM	PRESS THE PUSHBUTTON 
	INTERMITTENT ACOUSTIC SIGNAL REPEATED APPROX. EVERY 10 SEC.	
	MECHANICAL LOCKING IN STATE OF OCCLUSION OF THE INFUSION SET	ELIMINATE THE CAUSE AND PRESS THE PUSHBUTTON 
	INTERMITTENT ACOUSTIC SIGNAL REPEATED APPROX. EVERY 10 SEC.	
	MEMORY READING ERROR (EEPROM)	INITIALIZE THE DEVICE*
	INTERMITTENT ACOUSTIC SIGNAL REPEATED APPROX. EVERY 10 SEC.	
	MOTOR CIRCUIT SAFETY FAULT	INITIALIZE THE DEVICE
	INTERMITTENT ACOUSTIC SIGNAL REPEATED APPROX. EVERY 10 SEC.	
	THIS OPERATION CAN NOT BE PERFORMED PUSHBUTTON  LOCKED	CONSULT THE MANUAL PAGE 49
	INTERMITTENT ACOUSTIC SIGNAL REPEATED APPROX. EVERY 10 SEC.	
	THIS OPERATION CAN NOT BE PERFORMED KEYPAD LOCKED	CONSULT THE MANUAL PAGE 44
	ACOUSTIC SIGNAL LASTING ABOUT 5 SECONDS WHEN PRESSING THE PUSHBUTTON	

SECTION 16

The error messages shown on the display are accompanied by an acoustic signal and the subsequent shutdown of the system. No intentional delays have been introduced into the alarms, which are raised as soon as the safety system detects them.

NOTE



To initialize the device take out the battery and reinsert it after approx. 10/15 seconds.

*Warning



- After the **Er,8** signal and the subsequent initialization, the set parameters will be those set at the factory (see page 15): in this condition, it is therefore necessary to reprogram the parameters prescribed by the doctor.
- If after the corrective action or the initialization of the device, the error signal occurs again, stop using the pump and contact the technical assistance service.

CUSTOMER SUPPORT SERVICE

For further information about the **CRONO S-PID 50** pump contact:



Customer Service Assistance
401 Southwestern Blvd., Suite 160
Coppell, TX 75019 USA
Tel: 1-866-211-7867
www.intrapump.com

INSTRUCTIONS IN SHORT

Timed pushbuttons: they must be pressed for a few seconds before the command is executed.

Warning







These short instructions are not an alternative to reading the information in the manual but are an organic and quick synthesis of the functions of the device.

	ACTIVATION	PUSH-BUTTONS	DISPLAY	PAGE
BATTERY INSERTION	<ul style="list-style-type: none"> • Display segment complete switching on 			37
	<ul style="list-style-type: none"> • Firmware version display 			37
	<ul style="list-style-type: none"> • Program type display (flow rate/time) 			37
	<ul style="list-style-type: none"> • Access to the selection flow rate/time (only possible with L 0 access level) 			37
	<ul style="list-style-type: none"> • Flow rate/time parameter variation 			37
	<ul style="list-style-type: none"> • Automatic positioning of the pushing unit at the infusion start 			
	<ul style="list-style-type: none"> • Switching off the pump 			37











SECTION 17



	SETTINGS	PUSH-BUTTONS	DISPLAY	PAGE
PUMP OFF	Operations only possible with L 0 access level.			
	<ul style="list-style-type: none"> • Access to the infusion end alarm selection 	 1 ^a pressing	 	40
	<ul style="list-style-type: none"> • Access to the number of infusion sites selection (if -F- is selected) 	 2 ^a pressing		40
	<ul style="list-style-type: none"> • Access to the partial volume selection 	 3 ^a pressing		42
	Variation of the value of the previous parameters	/		

	FUNCTIONS	PUSH-BUTTONS	DISPLAY	PAGE
PUMP OFF	<ul style="list-style-type: none"> • Viewing the infusion number performed 			54
	<ul style="list-style-type: none"> • Anticipated withdrawal of the pushing unit 	and pressed at the same time		50
	<ul style="list-style-type: none"> • When switching on the pump, the display shows in sequence: 			47
	<ul style="list-style-type: none"> - The partial volume (if programmed) 			
	<ul style="list-style-type: none"> - The number of infusion sites (if -F- is selected) 			
	<ul style="list-style-type: none"> - The programmed flow rate (if -F- is selected) 			
<ul style="list-style-type: none"> - The programmed duration (if -t- is selected) 				
<ul style="list-style-type: none"> - The duration of the infusion 				

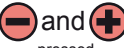





	FUNCTIONS	PUSH-BUTTONS	DISPLAY	PAGE
PUMP ON	<ul style="list-style-type: none"> When the pump is operational the displays shows the duration of the infusion expressed in hours and/or minutes. 			48
	<ul style="list-style-type: none"> If a number of infusion sites is set between 2 and 5, for example 2, the pump will proceed as follows: <ul style="list-style-type: none"> - 50% of the volume of the medication contained in the syringe will be administered in the first infusion site; - at the end of the partial administration, the display will show the indication End alternating with 1-2, it is now possible to change the infusion site; - restarting the infusion, administrering the remaining 50% of the medication available; - at the end of the partial administration, the display will show End and after a few seconds the pushing unit will return to the infusion start position. 		   	40-41

SECTION 17

	FUNCTIONS	PUSH-BUTTONS	DISPLAY	PAGE
PUMP ON	• Prime function 0.2 ml			48
	• Access to the flow rate or time value selection (with the L 0 access level)			44
				45
	• Variation of the flow rate or time value			
	• Switching flow rate/time displays (if -F- is selected)			47
• Switching off the pump	 pressed at the same time		54	











	INFUSION END	PUSH-BUTTONS	DISPLAY	PAGE
	• Infusion end			53
	• Withdrawal positioning of the pushing unit			
	• Switching off the pump			

SYMBOLS ON THE PUMP

SN	Serial no. of the pump
IP 42	<p>IP protection rating</p> <p>1st digit (4) = protection from solid objects larger than 1 mm. 2nd digit (2) = protection from water sprayed at an angle (up to 15° degrees from the vertical).</p>
 0476	CE marking
	<p>Electro-medical device</p> <p>Type BF</p>
	Warning, read the instructions before using
	Manufacturing date
	Manufacturer
	For use with doctor's prescription only
	<p>Sorted waste collection for electrical and electronic devices</p> <p>In accordance with article 13 of Legislative Decree no. 49 dated 14th March 2014, "Implementation of directive 2012/19/UE on waste electrical and electronic equipment (WEEE)".</p>
<p>The symbol of the crossed out waste bin on the product and its packaging indicates that at the end of its useful life, the product must be disposed of separately from other waste. Sorted waste disposal of products at the end of their useful life is organised and managed by the manufacturer. The user who wants to dispose of this device must therefore contact the manufacturer (or the appropriate local distributor) and follow the system which has been devised to allow for the sorted materials disposal of devices at the end of their useful lives. A proper sorted collection for devices destined for recycling, treating and environmentally compatible disposal, helps reduce the potentially negative impacts on the environment and health, and facilitates the re-use or recycling of the materials of which the device is constructed. The illegal disposal of a product is punishable according to the laws currently in force.</p>	

SECTION 18

SYMBOLS ON THE SYRINGE BLISTER PACKAGE

	Read the instructions
CE 0123	CE marking
	Recyclable
	Use only once
	Non-pyrogenic
	Keep dry
	Keep away from sunlight
	Expiry date
STERILE EO	Sterilized with ethylene oxide
PP	Polypropylene
LOT	Batch code
REF	Reference no.
Rx ONLY	For use with doctor's prescription only
	Latex Free
	Do not use if package is damaged
	Manufacturer

PRECISION TEST

The tests were performed in compliance with the standard IEC 60601-2-24, Electromedical Equipment, Part 2: Particular safety requirements for infusion pumps and controllers. The diagrams below show the accuracy of the pump during administration.

1.1 – Start-up flow rate

- Programmed flow rate: 1 ml/h.

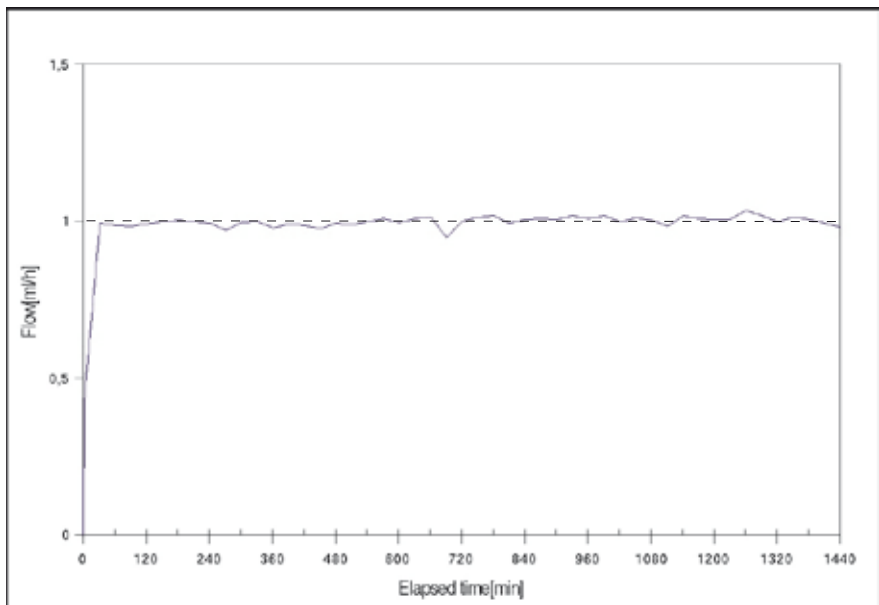

1.2 - Flow rate error (trumpet curve)

- Programmed flow rate: 1 ml/h.
- Mean error: +/- 2%.

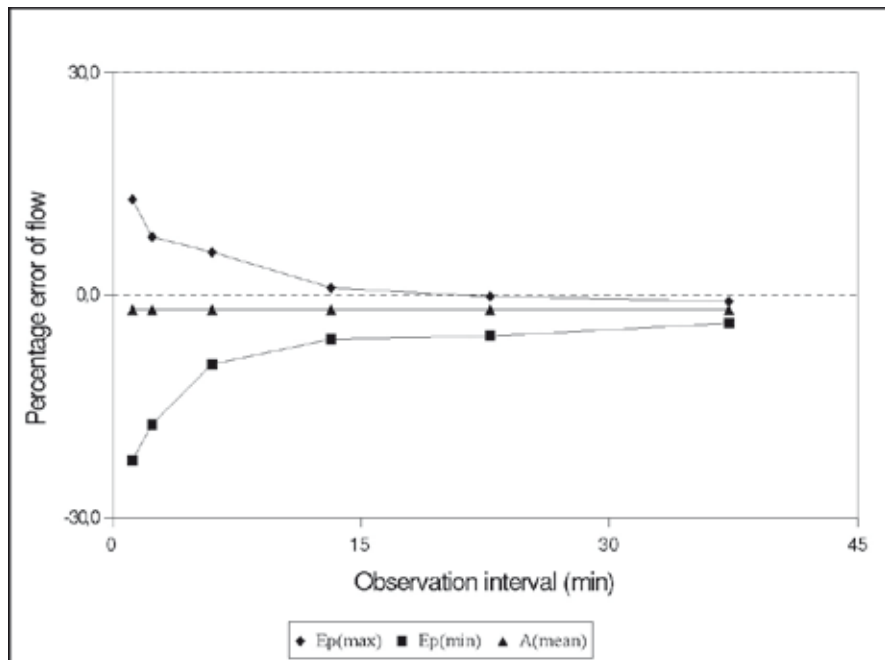

The accuracy level may deviate from the information in this manual according to the type of accessories and extensions used for the line to administer the medication.

TIME NEEDED TO SIGNAL AN OCCLUSION

The time necessary to signal an occlusion is the interval elapsing between the start of the occlusion condition and the detection of this situation by the pump; this value depends on the flow rate: the lower the flow rate, the longer the time required by the pump to detect the occlusion condition.

The values below consider the time required to signal an occlusion of the pump-syringe set.

Flow rate	Time needed to signal an occlusion
1.0 ml/h	About 2 hours and 15 minutes
25 ml/h	About 6 minutes
50 ml/h	About 4 minutes

Warning



The occlusion signal activation time depends on the flow rate; the lower its value, the longer the time the pump takes to activate the occlusion alarm.

The time necessary to signal an occlusion may increase if there is air inside the line, if catheters, filters and extensions are used of other sizes or made of elastic material, or when the pump line is connected to other devices.

For those patients who may suffer serious harm due to the interruption of the medication administration by the pump, a strict medical control must be arranged for possible immediate corrective actions to be taken.

POST-OCCLUSION BOLUS

When the occlusion alarm sounds, the pump has detected an excessive back pressure in the infusion line. This back pressure must be removed in order to avoid releasing a post-occlusion bolus, which might cause serious harm to the patient. The volume of the **CRONO S-PID 50**, post-occlusion bolus, considering only the combined volume of the pump and-reservoir, is approximately 2.1 ml.

Warning

- The volume of the bolus dose released post occlusion can increase if there is air in the line, if you are using catheters, filters and extension tubes of other dimensions or of a softer material, or when the line from the pump is connected to other devices.
- After the occlusion alarm sounds, take any and all measures appropriate to avoid the administration of a post-occlusion bolus to the patient.
- Patients who might suffer severe harm from the accidental release of a post-occlusion bolus must receive adequate instructions and/or training from medical or paramedical personnel on how to proceed in such a situation.

ELECTROMAGNETIC COMPATIBILITY

The electromagnetic compatibility tests were performed in compliance with standards:

- IEC 60601-2-24:2012, Electromedical devices, Part 2: Special safety requirements for infusion pumps and controllers;
- CEI EN 60601-1-2 2014, Electromedical devices, Part 1: General safety requirements - Collateral standard: Electromagnetic compatibility - Requirements and tests.

At a glance and manufacturer's statement - electromagnetic emissions		
The CRONO S-PID 50 is designed to operate in the electromagnetic environment specified below. The customer or user of the CRONO S-PID 50 must guarantee that it will be used in such an environment.		
Emission test	Compliance	Electromagnetic environment - at a glance
Emissions in RF CISPR 11	Group 1	The CRONO S-PID 50 only uses RF energy for its internal operation. Consequently, its RF emissions are very low and, probably, do not cause any interference with electronic devices situated near it.
Emissions in RF CISPR 11	Class B	The CRONO S-PID 50 is suitable for use in all environments including the home and those linked directly to public low voltage electricity mains supply powering buildings used for housing purposes.
Harmonic emissions IEC 61000-3-2	Not applicable	
Emissions following voltage fluctuations/ flickering IEC 61000-3-3	Not applicable	

At a glance and manufacturer's statement - electromagnetic immunity

The **CRONO S-PID 50** is designed to operate in the electromagnetic environment specified below. The customer or user of the **CRONO S-PID 50** must guarantee that it will be used in such an environment.

Immunity test	Test level IEC 60601	Conformity level	Electromagnetic environment - at a glance
Electrostatic discharge (ESD) IEC 61000-4-2	15 kV in air 8 kV a contact	15 kV in air 8 kV a contact	The flooring must be made of wood, concrete or ceramics. If the flooring is coated with syntethic material, the relative humidity should be at least 30%.

At a glance and manufacturer's statement - electromagnetic immunity

The **CRONO S-PID 50** is designed to operate in the electromagnetic environment specified below. The customer or user of the **CRONO S-PID 50** must guarantee that it will be used in such an environment.

Immunity test	Test level IEC 60601	Conformity level	Electromagnetic environment - at a glance
Radiated immunity	80-1000 MHz 10V/m AM 80% 1 KHz	10V/m	Interference was found near the devices marked with the following symbol: 

Recommended clearances between portable and mobile radio communication devices and the CRONO S-PID 50.

The **CRONO S-PID 50** is designed to operate in an electromagnetic environment where the RF interference radiated is kept under control. The customer or the operator of the **CRONO S-PID 50** can contribute towards minimizing electromagnetic interference by ensuring a minimum clearance between all mobile and portable RF communication devices (transmitters) and the **CRONO S-PID 50** as recommended below, according to the maximum output power of the radio communication devices.

Maximum specified outpower of the transmitter (W)	Clearance at the transmitter frequency (m)	
	80 MHz to 800 MHz	800 MHz to 2500 MHz
0,01	0,12	0,23
0,1	0,38	0,73
1	1,2	2,3
10	3,8	7,3
100	12	23

REFERENCE DIRECTIVES

- **Directive 93/42/EEC of the Council.**

Medical devices.

- **Directive 2007/47/EC of the European Parliament and of the Council.**

Amending directives 90/385/EEC of the Council on the approximation of the laws of the Member States relating to active implantable medical devices, 93/42/EEC of the Council concerning medical devices and 98/8/EC concerning the placing of biocidal products on the market.

TECHNICAL STANDARDS**• IEC 60601-1:2005/AMD1:2012**

Medical electrical equipment, Part 1: general requirements for basic safety and essential performance.

• IEC 60601-1-2:2014

General requirements for basic safety and essential performance
- Collateral standard: Electromagnetic compatibility - Requirements and tests.

• IEC 60601-1-11: 2015

General requirements for basic safety and essential performance -
Collateral Standard: Requirements for medical electrical equipment and medical electrical systems used in the home healthcare environment.

• IEC 60601-2-24:2012

Particular requirements for the basic safety and essential performance of infusion pumps and controllers.

• IEC 60529:1989/AMD2:2013

Degrees of protection provided by enclosures (IP Code).

ATTACHMENT 7

INFORMATION

For further information about the **CRONO S-PID 50** pump contact:



Customer Service Assistance
401 Southwestern Blvd., Suite 160
Coppell, TX 75019 USA
Tel: 1-866-211-7867
www.intrapump.com

NOTES

