

Respiratory Ventilation Products Portable Ventilators

United States Catalog



Table of contents

LTV® Series ventilator products3-23

ReVel® ventilator products24-31

LTV[®] Series



LTV Series ventilators

LTV Series ventilators



21102-001

LTV Series 1100 ventilator system

LTV Series 1100 ventilator, protective boots, AC adapter with power cord, dust cover, hand strap, circuit adapter and operator manual



18984-001

LTV Series 1150 system

LTV Series 1150 ventilator, protective boots, AC adapter with power cord, dust cover, hand strap, circuit adapter, operator manual and quick reference guide



18888-001

LTV Series 1200 system

LTV Series 1200 ventilator, protective boots, AC adapter with power cord, dust cover, hand strap, circuit adapter, low flow oxygen adapter, operator manual and quick reference guide



18888-201

LTV Series 1200 MR Conditional ventilator system

Ventilator with protective boots, AC adapter with power cord, dust cover, circuit adapter, low flow oxygen adapter, LTV 1200 MR Conditional floor stand, case of 5 MR-safe 15 ft circuits and operator manual



99503

LTV 1200 MR Conditional System with SprintPack™

LTV 1200 MR Conditional ventilator, protective boots, AC adapter with power cord, SprintPack™ bracket, SprintPack battery power system, dust cover, circuit adapter, low flow oxygen adapter, LTV 1200 MR Conditional floor stand, case of 5 MR-safe 15 ft circuits and operator manual

LTM II® Graphics Monitor and accessories



17650-001

LTM II Graphics Monitor package

LTM II Graphics Monitor, LTM mounting bracket, LTM II data cable, power splitter cable, compact flash card and LTM II operator manual

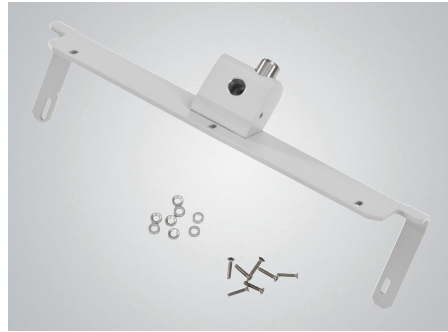

17916-001

Bracket, LTM® Graphics Monitor mounting

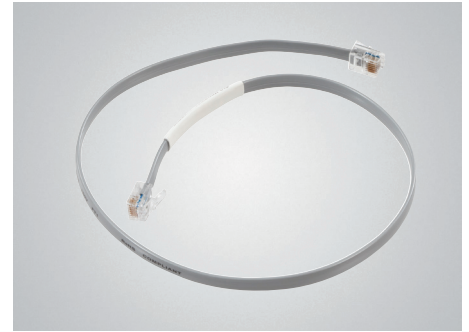

11089

Cable, LTM data, 21 in



11089-002

Cable, LTM data, 6 ft



18093-001

Cable, power splitter, LTM II



18097-001

Stylus pen, LTM



18098-001

Card, compact flash

LTV Series circuits

LTV Series 1100, 1150 and 1200 ventilator circuits without PEEP

Single-patient-use (SPU) circuits, 6 ft

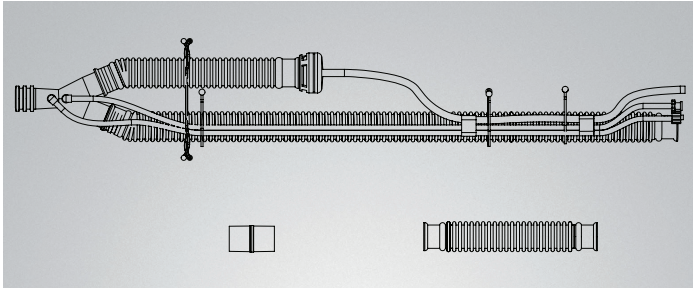

29657-001

Patient circuit without PEEP, 22 mm SPU (10/pkg)

1.8 m x 22 mm insp limb, wye and 61 cm x 22 mm exp limb

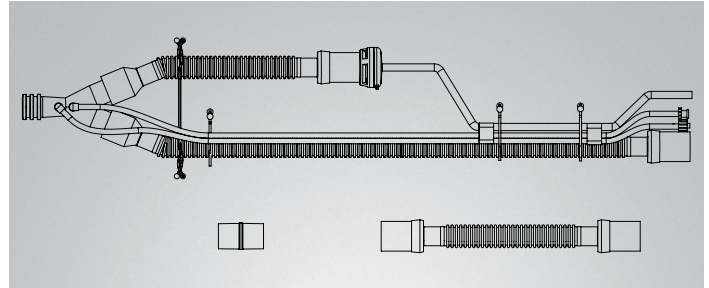

29658-001

Patient circuit without PEEP, 15 mm SPU (10/pkg)

1.8 m x 15 mm insp limb, wye and 61 cm x 15 mm exp limb

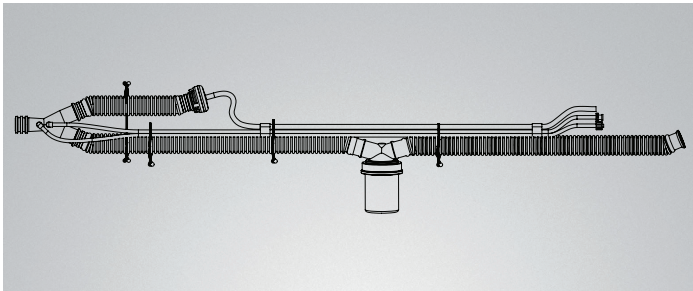

29663-001

Patient circuit without PEEP with 1 water trap, 22 mm SPU (10/pkg)

1.8 m x 22 mm insp limb with water trap, temp probe port, wye and 61 cm x 22 mm exp limb

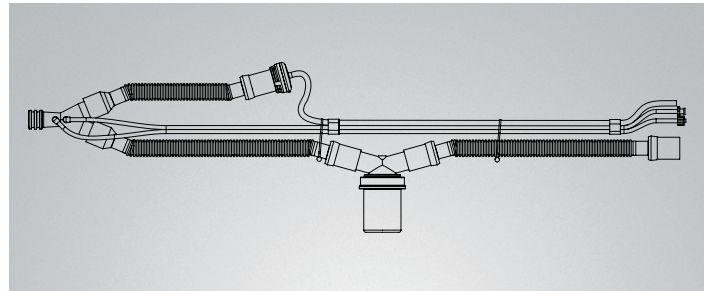

29662-001

Patient circuit without PEEP with 1 water trap, 15 mm SPU (10/pkg)

1.8 m x 15 mm insp limb with water trap, temp probe port, wye and 61 cm x 15 mm exp limb

Reusable circuits, 6 ft

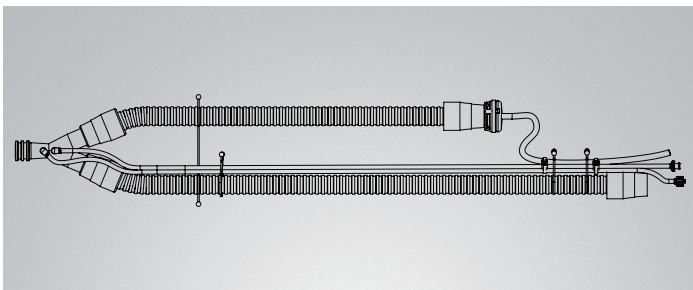

17997-001

Patient circuit without PEEP, 22 mm reusable (ea) (replaces 10815)

1.8 m x 22 mm insp limb, wye and 61 cm x 22 mm exp limb

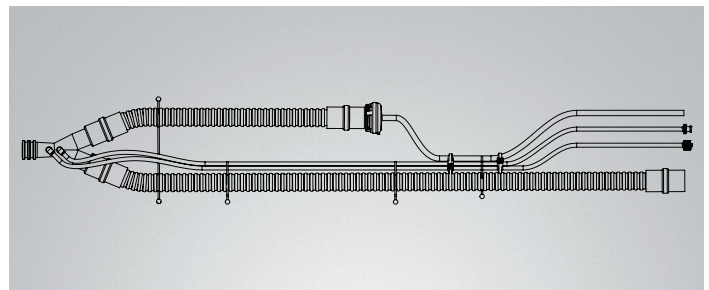

18941-001

Patient circuit without PEEP, 15 mm reusable (ea)

1.8 m x 15 mm insp limb, wye and 61 cm x 15 mm exp limb

LTV Series circuits

LTV Series 1100, 1150 and 1200 ventilator circuits without PEEP (continued)

SPU heated wire circuits for Fisher & Paykel humidifiers, 5.5 ft

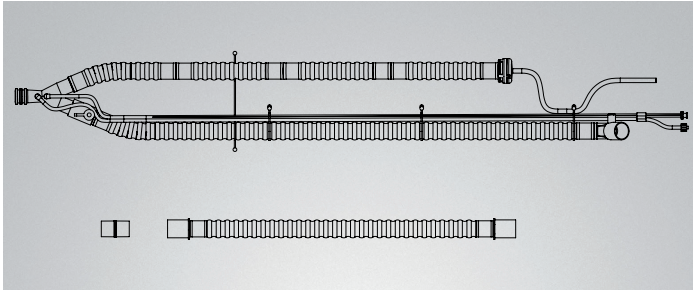

15090-102

Patient circuit without PEEP, 22 mm SPU single heated wire, Fisher & Paykel (10/pkg)

1.7 m x 22 mm heated insp limb, temp probe port, wye and 61 cm x 22 mm exp limb

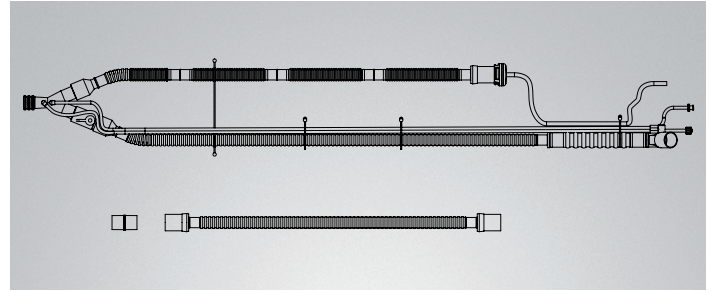

15090-104

Patient circuit without PEEP, 15 mm SPU single heated wire, Fisher & Paykel (10/pkg)

1.7 m x 15 mm heated insp limb, temp probe port, wye and 61 cm x 15 mm exp limb

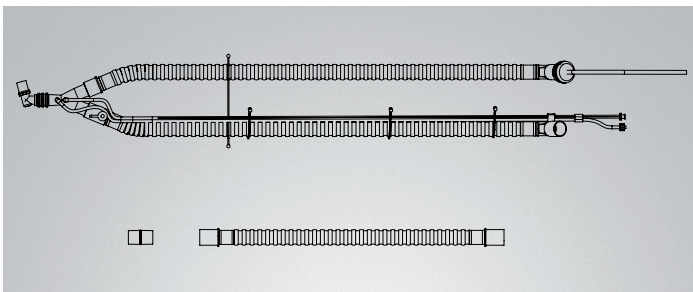

15091-102

Patient circuit without PEEP with elbow, 22 mm SPU dual heated wire, Fisher & Paykel (10/pkg)

1.7 m x 22 mm heated insp limb, temp probe port, wye, elbow and 61 cm x 22 mm heated exp limb

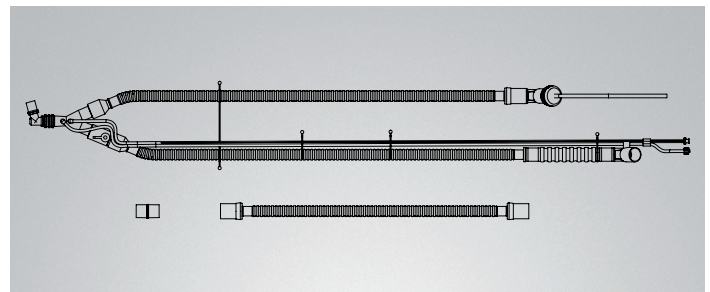

15091-104

Patient circuit without PEEP with elbow, 15 mm SPU dual heated wire, Fisher & Paykel (10/pkg)

1.7 m x 15 mm heated insp limb, temp probe port, wye, elbow and 61 cm x 15 mm heated exp limb

SPU MR-safe circuit, 15 ft

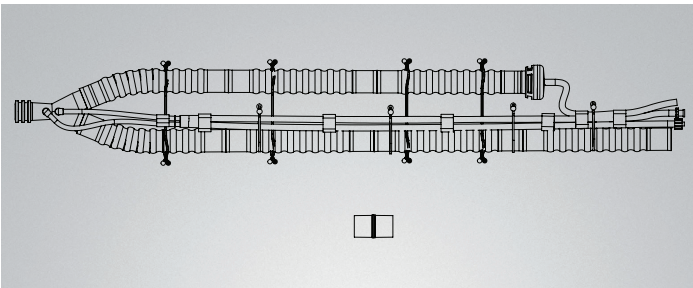

19189-001

Patient circuit without PEEP, 22 mm SPU, 15 ft (5/pkg)

LTV Series 900, 950 and 1000 ventilator circuits with PEEP

SPU circuits, 6 ft

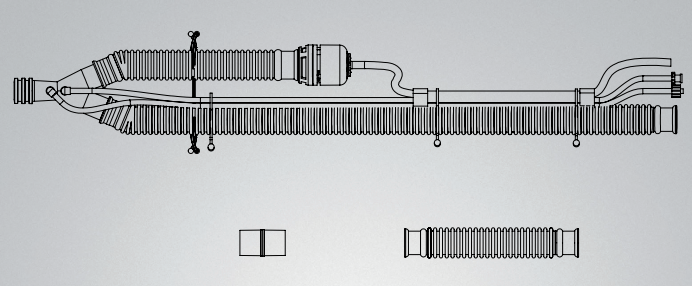

29695-001
Patient circuit with PEEP, 22 mm SPU (10/pkg)
1.8 m x 22 mm insp limb, wye and 61 cm x 22 mm exp limb

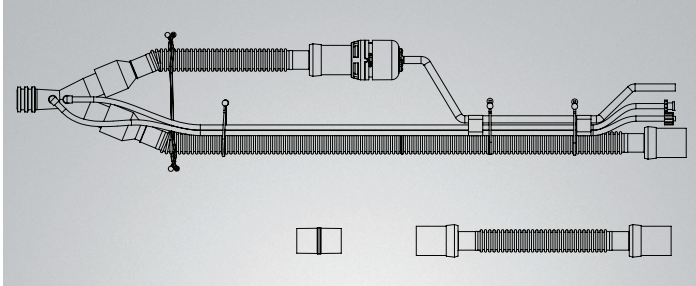

29710-001
Patient circuit with PEEP, 15 mm SPU (10/pkg)
1.8 m x 15 mm insp limb, wye and 61 cm x 15 mm exp limb

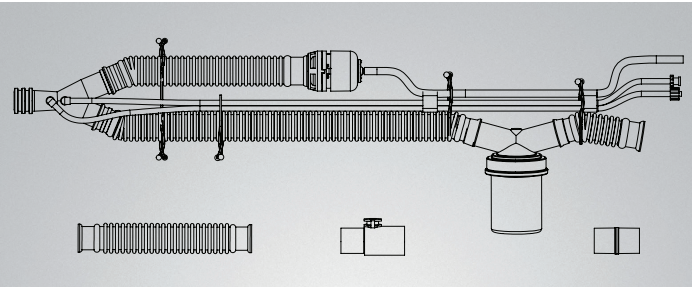

29697-001
Patient circuit with PEEP with 1 water trap, 22 mm SPU (10/pkg)
1.8 m x 22 mm insp limb with water trap, temp probe port, wye and 61 cm x 22 mm exp limb

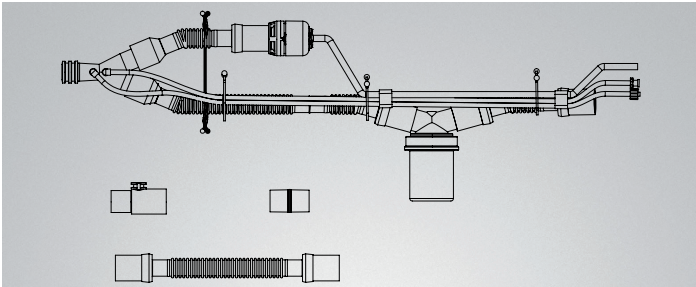

29696-001
Patient circuit with PEEP with 1 water trap, 15 mm SPU (10/pkg)
1.8 m x 15 mm insp limb with water trap, temp probe port, wye and 61 cm x 15 mm exp limb

LTV Series circuits

LTV Series 900, 950 and 1000 ventilator circuits with PEEP (continued)

SPU heated wire circuits for Fisher & Paykel humidifiers, 5.5 ft

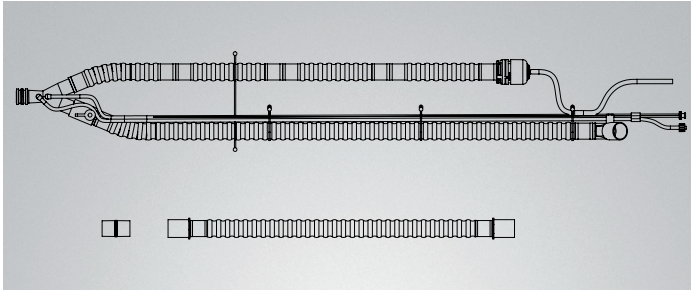

15090-101

Patient circuit with PEEP, 22 mm SPU single heated wire,
Fisher & Paykel (10/pkg)

1.7 m x 22 mm heated insp limb, temp probe port, wye
and 61 cm x 22 mm exp limb

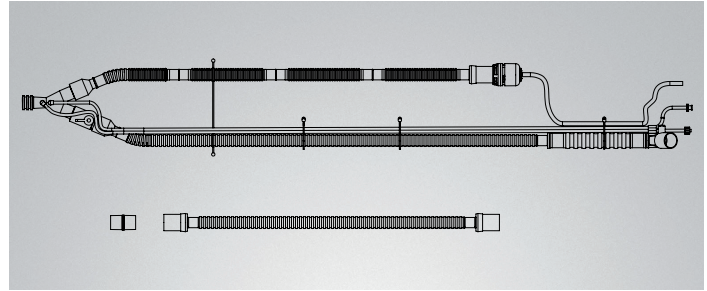

15090-103

Patient circuit with PEEP, 15 mm SPU single heated wire,
Fisher & Paykel (10/pkg)

1.7 m x 15 mm heated insp limb, temp probe port, wye
and 61 cm x 15 mm exp limb

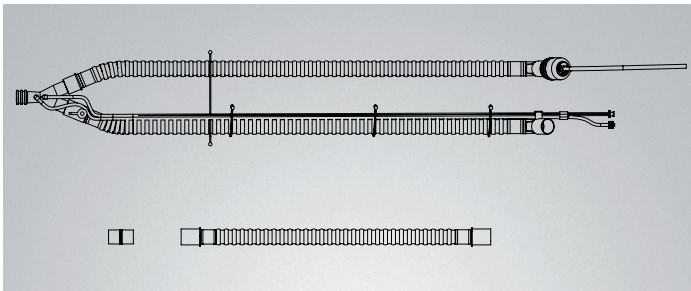

15091-101

Patient circuit with PEEP, 22 mm SPU dual heated wire,
Fisher & Paykel (10/pkg)

1.7 m x 22 mm heated insp limb, temp probe port, wye
and 61 cm x 22 mm heated exp limb

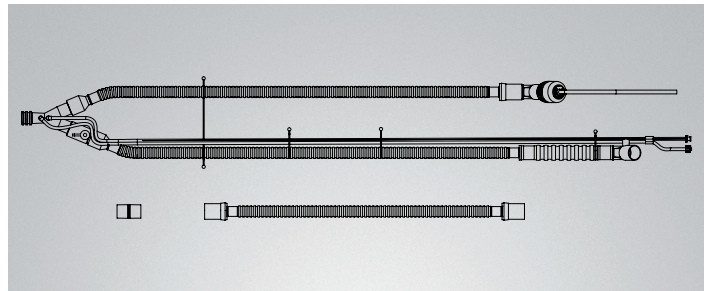

15091-103

Patient circuit with PEEP, 15 mm SPU dual heated wire,
Fisher & Paykel (10/pkg)

1.7 m x 15 mm heated insp limb, temp probe port, wye
and 61 cm x 15 mm heated exp limb

LTV Series circuits

LTV Series 800 ventilator circuits with PEEP and without flow sensor (for pressure triggering)

SPU circuits, 6 ft

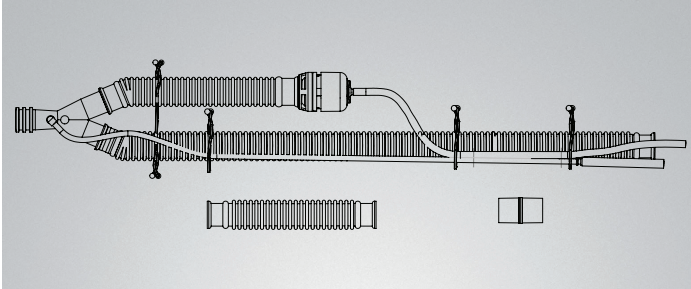

29715-001

Patient circuit with PEEP, 22 mm SPU (10/pkg)

1.8 m x 22 mm insp limb, wye and 61 cm x 22 mm exp limb

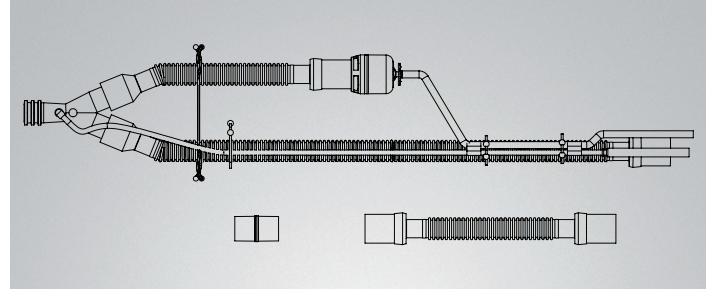

29716-001

Patient circuit with PEEP, 15 mm SPU (10/pkg)

1.8 m x 15 mm insp limb, wye and 61 cm x 15 mm exp limb

LTV Series circuit accessories



10696
Adapter, circuit



17921-001
Exhalation valve with PEEP, reusable
(replaces 10824)



18172-001
Exhalation valve without PEEP, reusable
(replaces 10825)



17486-101
Diaphragm, exhalation valve (for 17921-001
and 18172-001)

SprintPack™ Lithium-Ion Power System



19222-201

Power system, SprintPack lithium-ion with cable protector

SprintPack power manager, cable protector, 2 SprintPack batteries and operator manual

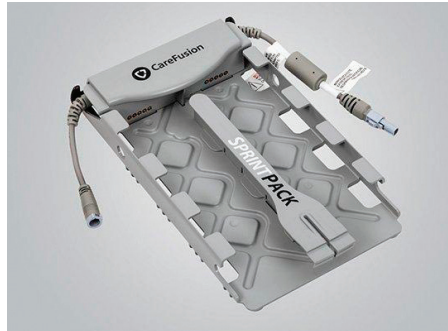

19333-201

Power manager, SprintPack with cable protector (Does not include SprintPack batteries)



19444-001

Battery, SprintPack



19096-001

Bracket, SprintPack mounting



19102-001

Transport pack for LTV and SprintPack

5 D-rings, detachable shoulder strap, hand strap and bedrail mount



11544

Cord, automotive power, 12 ft



19871-001

Mounting bracket, MR Conditional SprintPack



24555-001

SprintPack Cable Support Bracket

LTV Series power accessories and batteries

External sealed lead-acid batteries



10800
Battery kit, 9-hour external
12 V/33 amp-hour battery, battery box with strap, charger, battery cable and operator manual



10787
Battery, 9-hour external (12 V/33 amp-hour)



10790
Battery box with strap, external



10900
Battery kit, 3-hour external
12 V/12 amp-hour battery, padded battery bag with cable, charger, battery cable and operator manual



11475
Battery, 3-hour external (12 V/12 amp-hour)



10901
Cable, 3-hour external battery



11330
Bag with cable, padded battery
(for use with 3-hour battery)



10802
Cable, DC external battery
(for use with 3-hour and 9-hour battery)



10801
Charger, external battery
(for use with 3-hour and 9-hour battery)

Universal power supply (UPS)



17894-001
Battery, universal power supply

Miscellaneous power accessories



11448
AC power adapter with power cord, LTV



17527-001
AC power adapter without power cord, LTV



10854
Fuse, 32 V, 10 amp battery



11456
Electrical strip with 4 m power cord, 4-outlet U.S. hospital grade



11544
Cord, automotive power, 12 ft



10536
Power cord, 110 VAC hospital grade, 10 ft

LTV Series stands



10611
Stand with oxygen cylinder ring,
LTV Series floor



10695
Stand, LTV Series table

LTV Series ventilator stands, packs and mounting accessories

LTV Series mounts, packs and carries



10700
Mount, bedrail



11581-G
Backpack for LTV Series ventilators
with boots
(gray)



19102-001
Transport pack for LTV Series ventilators
and SprintPack
5 D-rings, detachable shoulder strap,
hand strap and bedrail mount

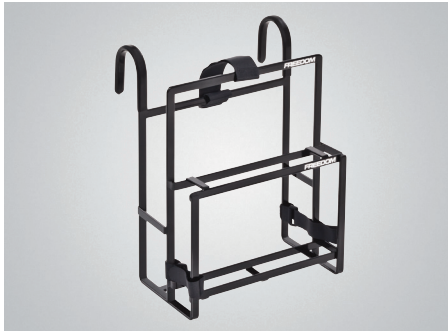

19184-001
Freedom carrier, LTV Series ventilators
and SprintPack

LTV Series stands, packs and mounting accessories

LTV Series mounting accessories

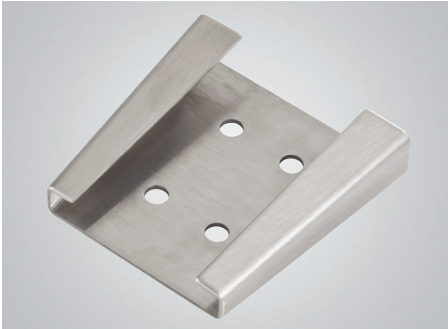

10610
Bracket, female dove-tail

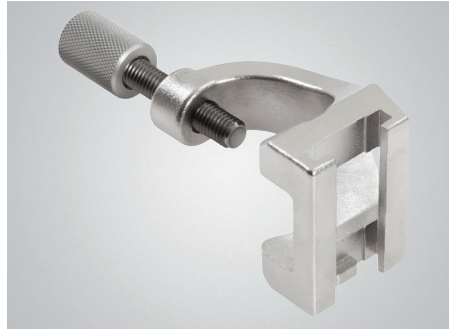

10979
Bracket, humidifier pole mount C-clamp



11454
Bracket, large battery mounting

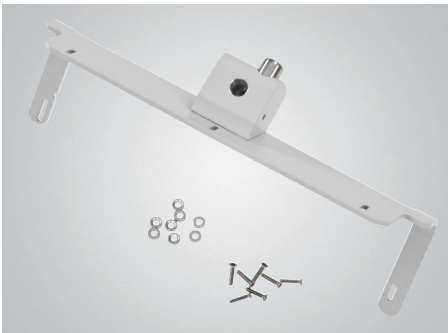

17916-001
Bracket, LTM Graphics Monitor mounting



19096-001
Bracket, SprintPack mounting



10658
Hand strap, LTV Series ventilators
(gray)



19031-001
Hand strap, LTV Series ventilators
(purple)



11501
Support arm with circuit hanger,
patient circuit

LTV Series mounting accessories *(continued)*

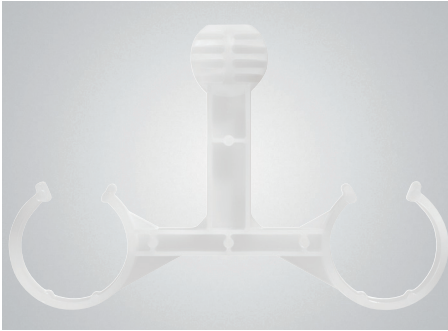

11503
Hanger, clip, circuit support arm

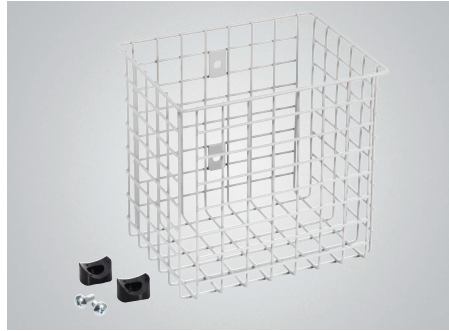

11450
Basket, utility

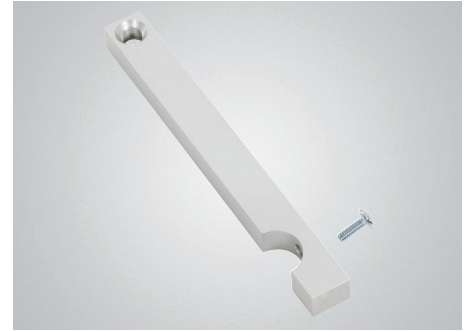

11451
Crossbar, short



11452
Crossbar, long



11453
Pole, humidifer



11455
Oxygen cylinder ring set
(for use with 10611)



17341-001
Strap, transport pack shoulder

LTV Series mounting accessories sold but not shown

Cat. No.	Description
CAS-1152	Caster for floor stand <i>(for use with 10611)</i>
CAS-1168	Caster for floor stand, locking <i>(for use with 10611)</i>

LTV Series stands, packs and mounting accessories

LTV Series mounting accessories (continued)



19870-001
L-bracket with screws for LTV Series MR Conditional floor stand



19871-001
Mounting bracket, LTV Series MR Conditional SprintPack



19873-001
Caster for LTV Series MR Conditional floor stand



19874-001
Caster for LTV Series MR Conditional floor stand, locking



19875-001
Oxygen cylinder ring set, LTV Series MR Conditional floor stand

LTV Series miscellaneous parts & accessories



34910
Cable, remote alarm, 50 ft
(for use with alarm 11553)



19103-001
Cable, remote alarm, BNC - phone, 20 ft



14647-001
Cable, nurse call splitter



10779
Cable, nurse call, normally closed



10780
Cable, nurse call, normally open



17986-001
Adapter, electrical, Fisher & Paykel 900 MR
900 dual heated limb



17987-001
Adapter, electrical, Fisher & Paykel 900 MR
901 single heated limb



10701
Adapter, low pressure oxygen

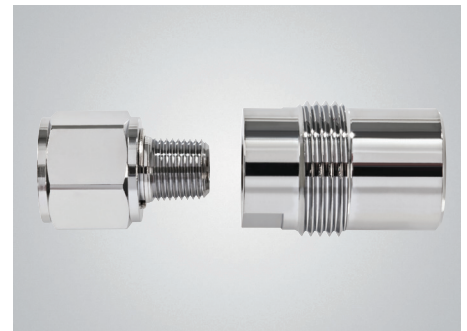

10702
Adapter, NIST oxygen

LTV Series miscellaneous parts & accessories

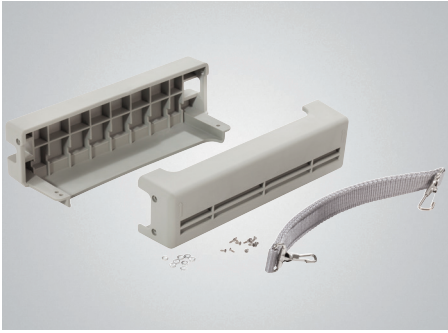

11550
Boot kit
(gray protective)



19175-001
Boot kit
(purple protective)



15016-001
Cap, blender



14446
Cap, tethered port
(for use with LTV Series 800, 900, 950, 1100 and 1150 ventilators)



18098-001
Card, compact flash

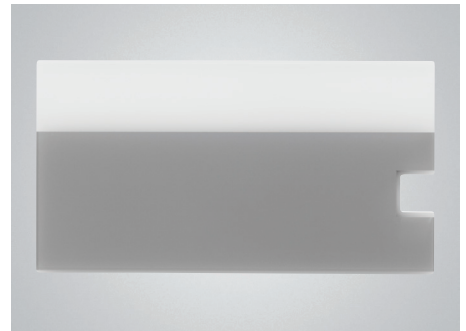

10109
Cover, front panel dust



11456
Electrical strip with 4 m power cord, 4-outlet
U.S. hospital grade



10678
Fan grill assembly
Fan grill, fan grill enclosure and fan filter

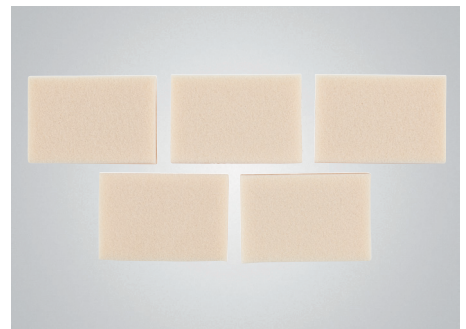

10258x5
Filter, LTV Series air inlet (5/pkg)

LTV Series ventilator miscellaneous parts & accessories

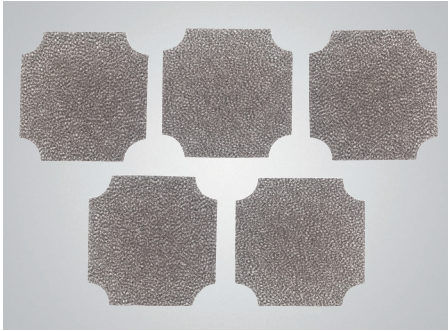

10789x5
Filter, LTV Series fan (5/pkg)



10699
Hose, 15 ft oxygen
(green)



11466
Test lung, 1L

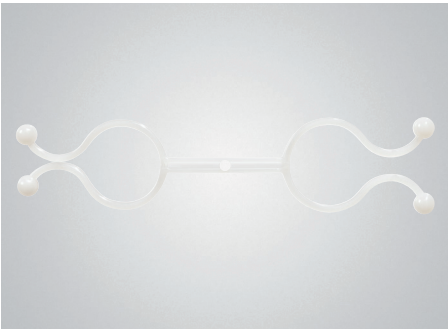

10934x50
Tie, circuit twist-lok, dual (50/pkg)

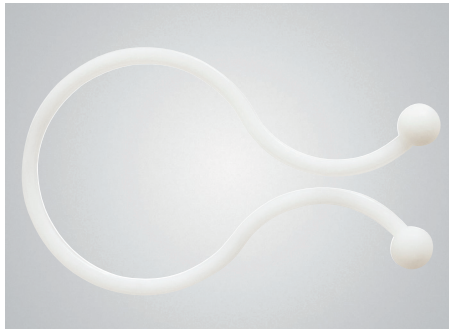

10936x50
Tie, circuit twist-lok, large (50/pkg)

LTV Series accessories, manuals & educational materials



LTV Series ventilator shipping carton

Cat. No.	Description
19818-001	Carton, shipping (replaces 17496-001)
17490-001	Sheet, divider (secures AC adapter)
17489-001	Sheet, divider (secures operator manual)
17487-001	Cap set, LTV end

Order all four parts

Cat. No.	Description
19802-001	Operator's Manual, LTV 1200/1150 English
19822-001	Quick Reference Guide, LTV 1200/1150 English
18999-001	In-Service DVD, LTV 1200 English
19990-001	Caregiver Training DVD, LTV 1150 English
19960-001	Emergency Set-Up DVD, LTV 1200 English
21106-001	Operator's Manual, LTV 1100 English
19795-001	Operator's Manual, LTV 1000/950/900 English
19819-001	Quick Reference Guide, LTV 1000/950/900 English
18581-001	In-Service CD/DVD, LTV 1000/950/900 English
18580-001	Caregiver Training DVD, LTV 1000/950/900 English
11600	Simulator CD, LTV 1000 English
17622-001	Recommended Settings Card, LTV 1000/950/900 English (25/pkg)
19797-001	Operator's Manual, LTV 800 English
19821-001	Quick Reference Guide, LTV 800 English
11524	Quick Reference Guide, HME/Hospital English
17754-001	Operator's Manual, LTM II Graphics Monitor English
11009	LTM Graphics Monitor CD, English
21188-001	Operator's Manual, LTV 1200/1150 Spanish
21196-001	Quick Reference Guide, LTV 1200/1150 Spanish
19799-001	Operator's Manual, LTV 1000/950/900 Spanish
19820-001	Quick Reference Guide, LTV 1000/950/900 Spanish

ReVel[®] ventilator



ReVel ventilator



19260-001

ReVel ventilator

ReVel ventilator, main battery, power adapter with power cord, oxygen (O₂) hose, carrying case, O₂ sensor cable, O₂ sensor, O₂ tee and operator manual



99260-001

ReVel system with floor stand and docking station

ReVel ventilator, main battery, O₂ hose, O₂ sensor cable, O₂ sensor, O₂ tee and operator manual; floor stand, patient circuit support arm, 3/16" hex wrench and instructions; docking station, protective cover, power cord and operator manual

PalmTop® Monitor (PTM) II graphics monitor



19400-001

PTM graphics monitor

Docking stations, stands and accessories



19270-001

Docking station

Docking station, protective cover, power cord and operator manual



21380-001

Protective collar, docking station

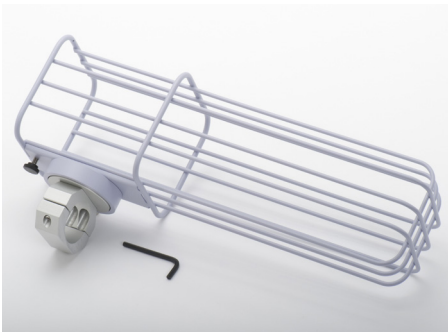

13914-001

Basket, O₂ cylinder (for use with floor stand 13912-001)



19574-001

Stand, table



13912-001

Stand, floor, with patient circuit arm

Floor stand, patient circuit support arm, 3/16" hex wrench and instructions

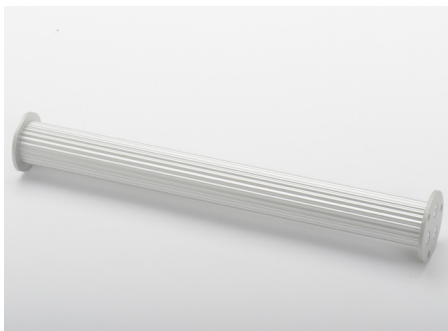

13886-001

Wall mount, humidifier pole



12140-001

Arm, patient circuit support

ReVel ventilator accessories

Docking stations, stands and accessories *(continued)*



19937-001
Mounting plate, docking station
(for use with GCX wall mounts)



12695-002
ReVel carry case



24737-001
PTV Transport Bracket for bed rail
and pole mounting. Includes PalmTop
mounting accessory and clamp.
Packaged preassembled.



24736-001
PTV Transport Bracket for L-Track mounting.
Includes PalmTop mounting accessory
and semi-permanent hardware.
Assembly required.



18098-001
Card, compact flash

Power accessories and batteries



12103-001
Power adapter with power cord, 110 VAC



13955-001
Charger, desktop battery with 110 VAC
power cord *(batteries not included)*



10536
Power cord, 110 VAC, hospital grade, 10'

Power accessories and batteries (continued)



13908-001
Battery, main lithium-ion



12102-001
Adapter, automobile power point, 12'

Miscellaneous parts and accessories



10699
Hose, O₂, 15'



13036-001
Sensor, O₂



13037-001
T-Piece, reusable O₂ sensor



13038-001
T-Piece, SPU O₂ sensor (10/pkg)

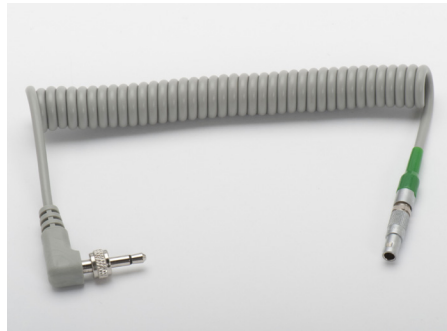

13897-001
Cable, O₂ sensor



18602-001
Cable, SpO₂

ReVel ventilator accessories

Miscellaneous parts and accessories *(continued)*



13063-001
Adapter and cable, VOXP data



19826-001
Filter, air inlet



19833-001
Filter, fan (10/pkg)



11466
Test lung, 1L

ReVel ventilator
accessories sold but
not shown

Cat. No.	Size	Qty.
19463-001	SpO ₂ Flexi-Form II, SPU adult	10/pkg
19464-001	SpO ₂ Flexi-Form II, SPU pediatric	10/pkg
19465-001	SpO ₂ Flexi-Form II, SPU infant	10/pkg
21311-001	SpO ₂ Flexi-Form III, SPU adult	24/pkg

ReVel circuits

SPU circuits, 6'

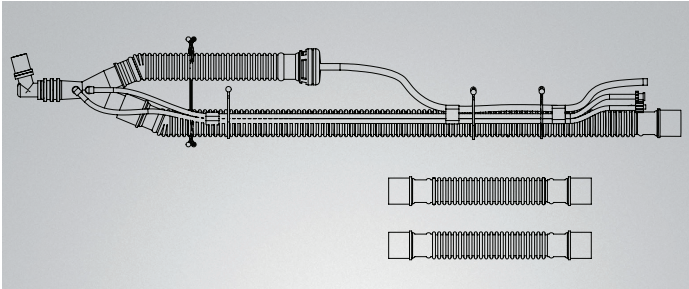

14858-001

Patient circuit without PEEP with elbow, 22mm SPU (10/pkg)

with 1.8 m x 22 mm ID inspiratory limb, wye, elbow and 61 cm x 22 mm expiratory limb

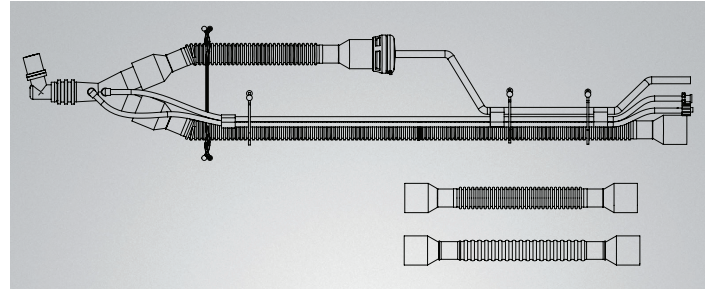

14859-001

Patient circuit without PEEP with elbow, 15mm SPU (10/pkg)

with 1.8 m x 15 mm ID inspiratory limb, wye, elbow and 61 cm x 15 mm expiratory limb

SPU heated wire circuits for Fisher & Paykel (F&P) humidifiers, 5.5'

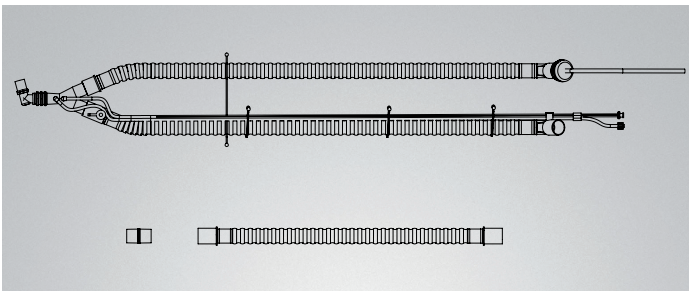

15091-102

Patient circuit without PEEP with elbow, 22 mm SPU dual heated wire, F&P (10/pkg)

with 1.7 m x 22 mm ID heated inspiratory limb, temp probe port, wye, elbow and 61 cm x 22 mm heated expiratory limb

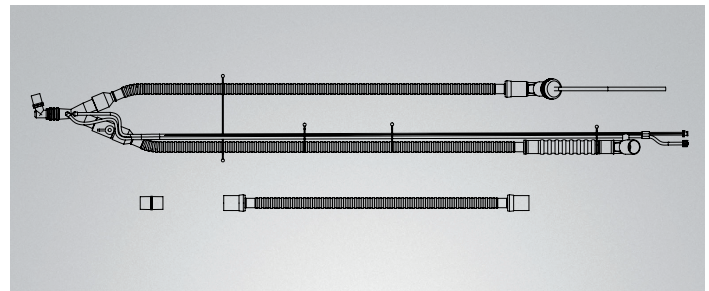

15091-104

Patient circuit without PEEP with elbow, 15 mm SPU dual heated wire, F&P (10/pkg)

with 1.7 m x 15 mm ID heated inspiratory limb, temp probe port, wye, elbow and 61 cm x 15 mm heated expiratory limb

Circuit accessories

Cat. No.	Description
18225-001	Patient wye and sense lines, reusable

Terms and Conditions

Minimum order of \$50.00 required

Terms and Conditions of Sale:

Pricing and warranties are subject to change without notice. All goods and services are sold subject to the seller's terms and conditions of sale. A copy of these terms and conditions is available on request.

Merchandise Return Policy:

1. Please contact our Customer Care Team for a Return Material Authorization (RMA) number prior to returning merchandise
2. Customers may return unopened and unused product within 30 days
3. All Products are subject to a 20% restocking fee
4. Please be prepared with the following information:
Item number, Serial or Lot Number, with Purchase Order or Sales Order Number

To place an order or for more information, please contact Customer Service at:

Phone:

800-754-1914 United States

763-398-8300 International

Fax:

763-398-8359 United States

763-398-8403 International

Email:

ACVentCare@carefusion.com

LTV Series ventilators						ReVel ventilators	
10109	21	11600	23	19795-001	23	10536	27
10258x5	21	14446	21	19797-001	23	10699	28
10536	14	14647-001	20	19799-001	23	11466	29
10610	17	15016-001	21	19802-001	23	12102-001	28
10611	15	15090-101	9	19818-001	23	12103-001	27
10658	17	15090-102	7	19819-001	23	12140-001	26
10678	21	15090-103	9	19820-001	23	12695-002	27
10695	15	15090-104	7	19821-001	23	13036-001	28
10696	11	15091-101	9	19822-001	23	13037-001	28
10699	22	15091-102	7	19870-001	19	13038-001	28
10700	16	15091-103	9	19871-001	12, 19	13063-001	29
10701	20	15091-104	7	19873-001	19	13886-001	26
10702	20	17341-001	18	19874-001	19	13897-001	28
10779	20	17486-101	11	19875-001	19	13908-001	28
10780	20	17487-001	23	19960-001	23	13912-001	26
10787	13	17489-001	23	19990-001	23	13914-001	26
10789x5	22	17490-001	23	21102-001	4	13955-001	27
10790	13	17527-001	14	21106-001	23	14858-001	30
10800	13	17622-001	23	21188-001	23	14859-001	30
10801	13	17650-001	5	21196-001	23	15091-102	30
10802	13	17754-001	23	24555-001	12	15091-104	30
10854	14	17894-001	14	29657-001	6	18098-001	27
10900	13	17916-001	5, 17	29658-001	6	18225-001	30
10901	13	17921-001	11	29662-001	6	18602-001	28
10934x50	22	17986-001	20	29663-001	6	19260-001	25
10936x50	22	17987-001	20	29695-001	8	19270-001	26
10979	17	17997-001	6	29696-001	8	19400-001	25
11009	23	18093-001	5	29697-001	8	19463-001	29
11089-002	5	18097-001	5	29710-001	8	19464-001	29
11089	5	18098-001	5, 21	29715-001	10	19465-001	29
11330	13	18172-001	11	29716-001	10	19574-001	26
11448	14	18580-001	23	34910	20	19826-001	29
11450	18	18581-001	23	99503	4	19833-001	29
11451	18	18888-001	4	CAS-1152	18	19937-001	27
11452	18	18888-201	4	CAS-1168	18	21311-001	29
11453	18	18941-001	6			21380-001	26
11454	17	18984-001	4			24736-001	27
11455	18	18999-001	23			24737-001	27
11456	14, 21	19031-001	17			99260-001	25
11466	22	19096-001	12, 17				
11475	13	19102-001	12, 16				
11501	17	19103-001	20				
11503	18	19175-001	21				
11524	23	19184-001	16				
11544	12, 14	19189-001	7				
11550	21	19222-201	12				
11581-G	16	19333-201	12				
		19444-001	12				



CareFusion
Yorba Linda, CA

carefusion.com



CareFusion

© 2017 CareFusion Corporation or one of its subsidiaries. All rights reserved.
LTV, ReVel, CareFusion and the CareFusion logo are trademarks or registered
trademarks of CareFusion Corporation or one of its subsidiaries. RC8019 (0217/PDF)